

CORAL

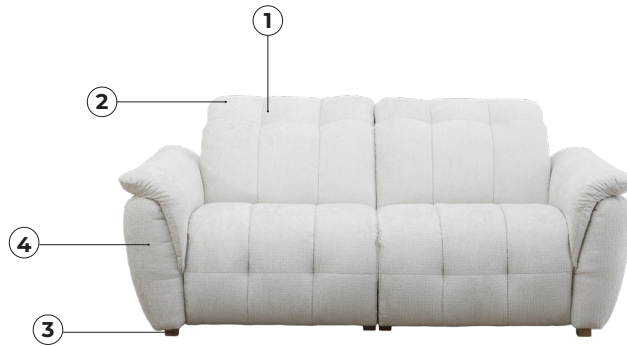

VILMERS

CORAL



Comfort

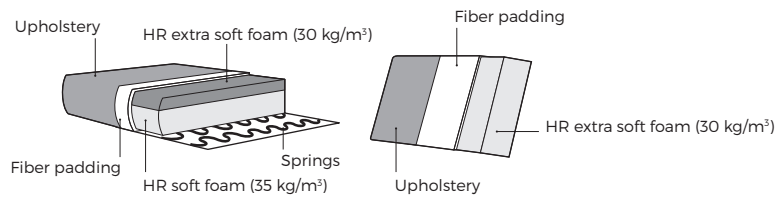

1. Upholstery



* Leather and fabric upholstery contain the same number of stitches.

2. Headrest & seat type

- 1 Manual ↶
- 2 Electrical ⏻

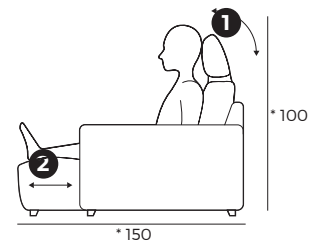

* Measurements for fully opened mechanism.

3. Legs



608 With CORAL, OMEGA armrests

590 With MIRAGE armrest
607 With SHARE armrest

4. Armrests



CORAL
W 24 x D 115 x H 60

MIRAGE
W 25 x D 111 x H 64

SHARE
W 19 x D 111 x H 64

OMEGA
W 5 x D 109 x H 50

IMPORTANT:

Upholstered furniture is handmade using soft materials, therefore measurements can vary in all modules by up to +/- 2 cm.
Modules and combinations shown in 2D drawings are left-sided. Modules and combinations can be mirrored from left to right.
Parts with a mechanism always have fibertex covered sides.

Sofa mechanism with two motors.

Each module of this product has different width of vertical seam splitting gaps, so you can get an uneven visual appearance when connecting different modules.

Modules (Measurements with CORAL armrest)

Scale 1:100

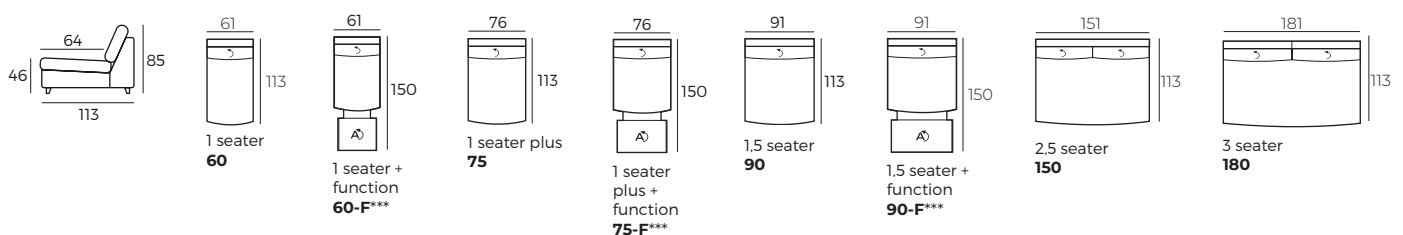

*** Vintage leather selection is not available.

CORAL

Modules (Measurements with CORAL armrest)

Scale 1:100

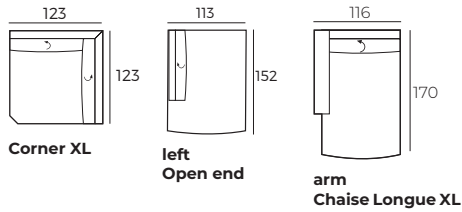

Modules with armrest (Measurements with CORAL armrest)

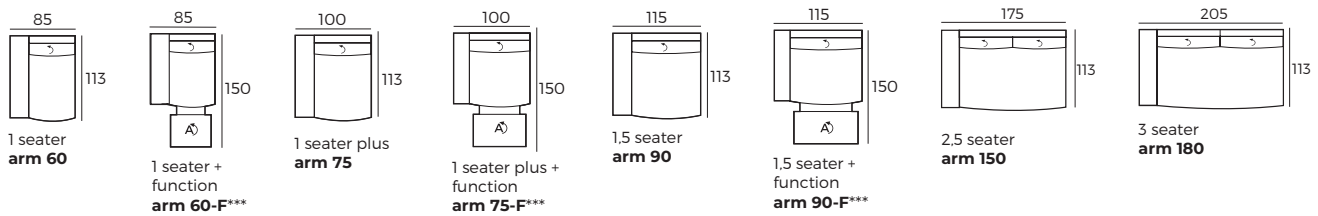

Combinations (Measurements with CORAL armrest)

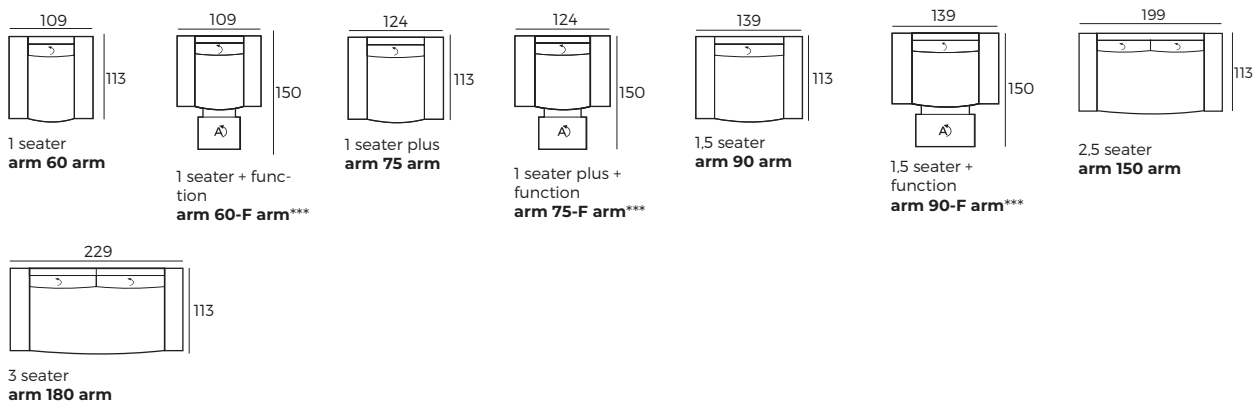

Accessories

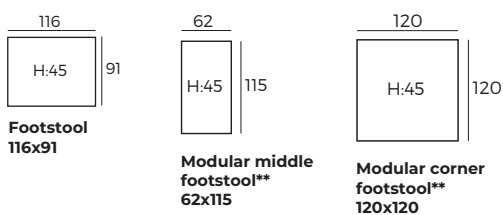

↵ - manual; ⚡ - electrical *F - single electric function. *D - double electric function

** These footstools are only available when used in modular configurations.

*** Vintage leather selection is not available.