

# MIRAGE



# VILMERS

# MIRAGE



Loose fit



Functional



Covered sides



Fix cushions



## Comfort

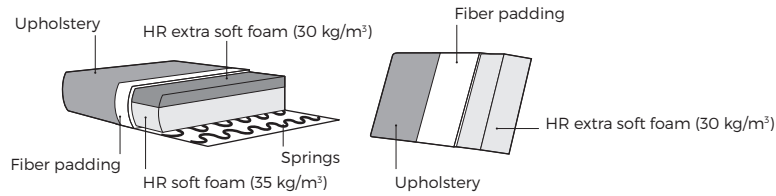

### 1. Upholstery

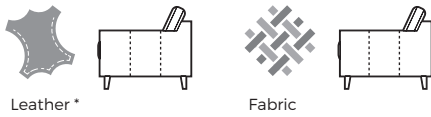

\* Leather and fabric upholstery contain the same number of stitches.

### 2. Headrest & seat type

- 1 Manual ↘
- 2 Electrical ↗

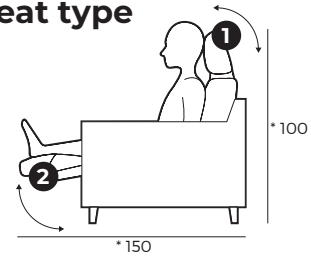

\* Measurements for fully opened mechanism.

### 3. Legs



### 4. Armrests



#### IMPORTANT:

Upholstered furniture is handmade using soft materials, therefore measurements can vary in all modules by up to **+/- 2 cm**.

Modules and combinations shown in 2D drawings are left-sided. Modules and combinations can be mirrored from left to right.

Each module of this product has different width of vertical seam splitting gaps, so you can get an uneven visual appearance when connecting different modules.

## Modules (Measurements with MIRAGE armrest)

Scale 1:100

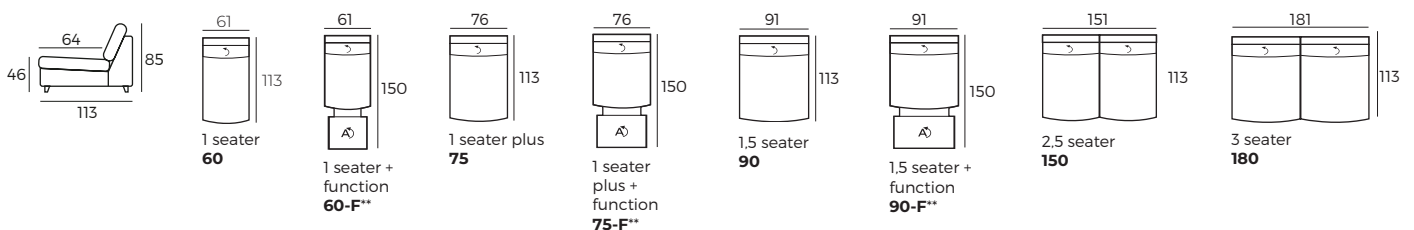

\*\*Vintage leather selection is not available.

**REST ASSURED**  
vilmers.com

# MIRAGE

## Modules (Measurements with MIRAGE armrest)

Scale 1:100

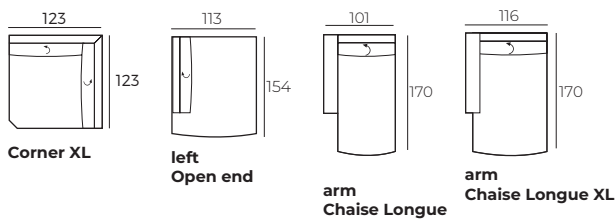

## Modules with armrest (Measurements with MIRAGE armrest)

Scale 1:100

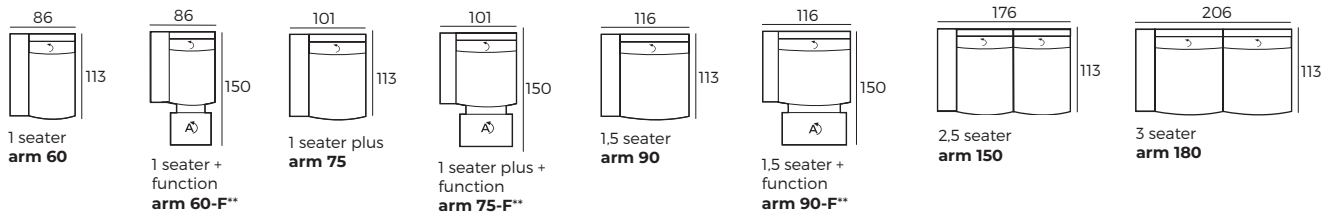

## Combinations (Measurements with MIRAGE armrest)

Scale 1:100

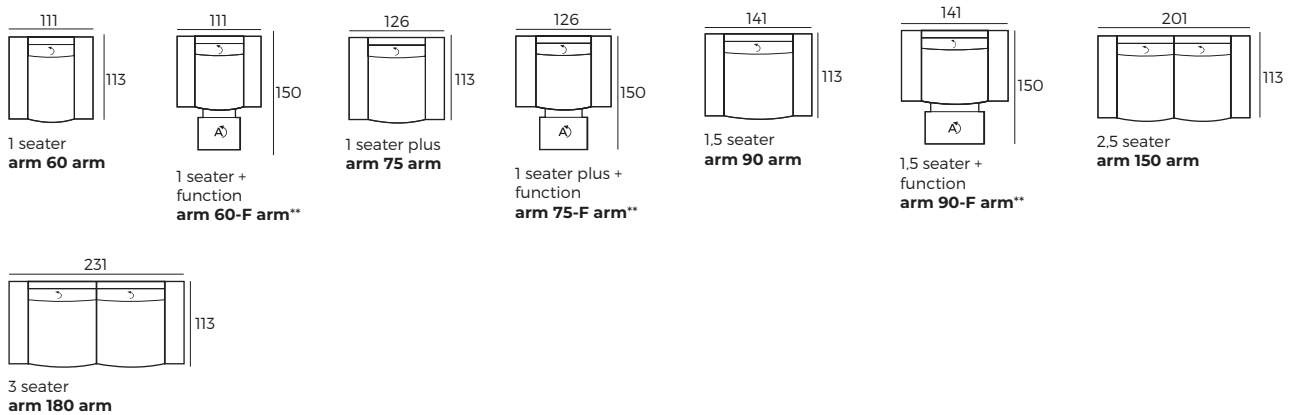

## Accessories

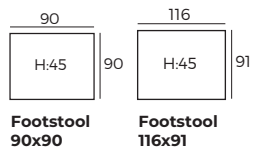

⌋ - manual; Ⓐ - electrical \*F - single electric function; \*D - double electric function

\*\*Vintage leather selection is not available.