

DESCRIPTION

Winner of the 2019 BigSee Wood Award, the Mela chair boasts a distinct character and classic style, drawing inspiration from mid-century design. Versatile in purpose, it serves as an exquisite choice for occasional or dining seating, making it equally suitable for residential and contract settings. The Mela chair presents a choice of seven distinct wood types, enriched by an array of natural finishes. Personalise the Mela chair with upholstery options, including a curated selection of leathers or fabrics.

PRODUCTION PROCESS

The chair parts are made of solid wood pieces of the same length but different widths, with precisely crafted joints on CNC machines. Each piece is chosen through careful matching of wood colors and structures. The upholstered seats are covered with HR foam and upholstery for superior comfort. Certain chair collections are produced using a special wood bending technology. The technical parameters of hand-assembled chairs comply with standard requirements. Final sanding is done manually with fine-grained sandpaper, and various types of finishes enable a wide selection of the chair's final appearance.

PRODUCT TYPE

Armchair

USAGE

Indoor

DISMANTLING OPTION

No

GLIDERS

Standard gliders

STOCK ITEMS

No

COUNTRY OF ORIGIN

BiH

NOTE

Available with an upholstered backrest and without decoration rings. The listed weights are approximate; the weight of each piece depends on the type of wood.

DIMENSIONS

Height: 77 cm / 30.31 in
Width: 59 cm / 23.22 in
Depth: 52 cm / 20.47 in
Seat height: 46 cm (upholstered seat) / 18.11 in

Seat size: 45x42.5cm / 17.71x16.73 in
Armrest height: 70 cm / 27.55 in

PACKAGING

Stretch wrap + five-layer cardboard box.
1 piece

PACKAGING DIMENSIONS

Height: 85 cm / 33.46 in
Width: 55 cm / 21.65 in
Depth: 65 cm / 25.59 in

WEIGHT

Weight: 8.5 kg
Packaging: 1.5 kg

MATERIALS

Oak, American and European walnut, elm, cherry, maple, ash

WOOD FINISHES

Available in a variety of natural oil and soap finishes. Discover more information artisan.ba/materials

UPHOLSTERY

Available in a variety of leathers and fabrics. More information at artisan.ba/materials

DECORATION RINGS FINISHES

Inox, Brass, powder-coated steel rings in black, white or anthracite color. Additional colors on request.

CLEANING INSTRUCTIONS

Please download our material care & cleaning instructions through artisan.ba/materials

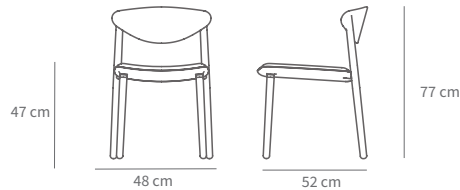

DESCRIPTION

The Naru Light Chair, a reinterpretation of the timeless Naru chair design. Crafted with a gently rounded backrest and graceful slender legs, this chair infuses any space with a sense of youthful vitality and an airy ambiance. The seat and / or back can be lavishly upholstered with premium leather or exquisite fabrics, allowing for a personalised look. Elevate your design with the choice of metal accents, adding a touch of sophistication to your space.

PRODUCTION PROCESS

The chair parts are made of solid wood pieces of the same length but different widths, with precisely crafted joints on CNC machines. Each piece is chosen through careful matching of wood colors and structures. The upholstered seats are covered with HR foam and upholstery for superior comfort. Certain chair collections are produced using a special wood bending technology. The technical parameters of hand-assembled chairs comply with standard requirements. Final sanding is done manually with fine-grained sandpaper, and various types of finishes enable a wide selection of the chair's final appearance.

PRODUCT TYPE

Armchair

USAGE

Indoor

DISMANTLING OPTION

No

GLIDERS

Standard gliders

STOCK ITEMS

No

COUNTRY OF ORIGIN

BiH

NOTE

The listed weights are approximate; the weight of each piece depends on the type of wood.

DIMENSIONS

Height: 77 cm/ 30.31 in

Width: 48 cm/ 18.89 in

Depth: 52 cm/ 20.47 in

Seat height: 45 cm wooden seat, 47 cm upholstered / 17.72 in wooden seat, 18.50 in upholstered

Seat size: 44x46 cm / 17.32x 18.11 in

PACKAGING

Stretch wrap + five-layer cardboard box.

1 piece

PACKAGING DIMENSIONS

Height: 85 cm/ 33.46 in

Width: 55 cm/ 21.65 in

Depth: 55 cm/ 21.65 in

WEIGHT

Weight: 5.5 kg

Packaging: 1.5 kg

MATERIALS

Oak, American and European walnut, elm, cherry, maple, ash

WOOD FINISHES

Available in a variety of natural oil and soap finishes. Discover more information artisan.ba/materials

UPHOLSTERY

Available in a variety of leathers and fabrics. More information at artisan.ba/materials

DECORATION RINGS FINISHES

Inox, Brass, powder-coated steel rings in black, white or anthracite color.

Additional colors on request.

CLEANING INSTRUCTIONS

Please download our material care & cleaning instructions through artisan.ba/materials

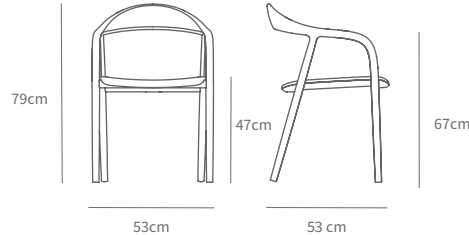

DESCRIPTION

Neva chair is one of Artisan's most celebrated pieces. Recognised for prestigious awards such as the Interior Innovation Award, German Design Award Nominee, and Design Intelligence Award, the Neva Chair exemplifies a captivating blend of fluid design. Its exquisite form emerges through a seamless fusion of soft, angular edges and transitions, while the tilted and arched backrest gracefully merges with the armrests, forming an uninterrupted line that elegantly extends into the front legs. Its timeless profile adapts to a wide range of interiors, from formal dining rooms to relaxed hospitality settings. Explore its versatility further with a choice of solid wood frames in a range of species, and upholstery options in leather or fabric, allowing you to curate the perfect seating solution for your space.

PRODUCTION PROCESS

The chair parts are made of solid wood pieces of the same length but different widths, with precisely crafted joints on CNC machines. Each piece is chosen through careful matching of wood colors and structures. The upholstered seats are covered with HR foam and upholstery for superior comfort. Certain chair collections are produced using a special wood bending technology. The technical parameters of hand-assembled chairs comply with standard requirements. Final sanding is done manually with fine-grained sandpaper, and various types of finishes enable a wide selection of the chair's final appearance.

PRODUCT TYPE

Armchair

USAGE

Indoor

DISMANTLING OPTION

No

GLIDERS

Standard gliders

STOCK ITEMS

No

COUNTRY OF ORIGIN

BiH

NOTE

The listed weights are approximate; the weight of each piece depends on the type of wood.

DIMENSIONS

Height: 79cm / 31.10 in

Width: 53 cm / 20.86 in

Depth: 53 cm / 20.86 in

Seat height: 45 cm (wooden seat) / 17.72 in

Upholstered seat is 2cm / 0,78 in higher than wooden seat

Seat size: 46x47cm / 18.11x18.7 in

Armrest height: 67 cm / 26.38 in

PACKAGING

Stretch wrap + five-layer cardboard box.

1 piece

PACKAGING DIMENSIONS

Height: 80 cm / 31.5 in

Width: 55 cm / 21.65 in

Depth: 55 cm / 21.65 in

WEIGHT

Weight: 8.5 kg

Packaging: 1.5 kg

WOOD

Oak, American and European walnut, elm, cherry, maple, ash

WOOD FINISHES

Available in a variety of natural oil and soap finishes. Discover more information artisan.ba/materials

UPHOLSTERY

Available in a variety of leathers and fabrics.

More information at artisan.ba/materials

CLEANING INSTRUCTIONS

Please download our material care & cleaning instructions through artisan.ba/materials

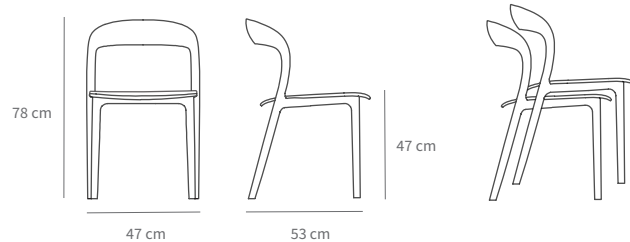

DESCRIPTION

The Neva Light chair distills the signature elements of the original Neva design into a more minimal form. It features an open, sculptural frame with a gently curved backrest and slender proportions. The result is a visually lightweight chair that retains the comfort and craftsmanship of the original Neva design. Explore its versatility further with a choice of solid wood frames in a range of species, and upholstery options in leather or fabric, allowing you to curate the perfect seating solution for your space.

PRODUCTION PROCESS

The chair parts are made of solid wood pieces of the same length but different widths, with precisely crafted joints on CNC machines. Each piece is chosen through careful matching of wood colors and structures. The upholstered seats are covered with HR foam and upholstery for superior comfort. Certain chair collections are produced using a special wood bending technology. The technical parameters of hand-assembled chairs comply with standard requirements. Final sanding is done manually with fine-grained sandpaper, and various types of finishes enable a wide selection of the chair's final appearance.

PRODUCT TYPE

Chair

USAGE

Indoor

DISMANTLING OPTION

No

GLIDERS

Standard gliders

STOCK ITEMS

No

COUNTRY OF ORIGIN

BiH

NOTE

The listed weights are approximate; the weight of each piece depends on the type of wood.

DIMENSIONS

Height: 78 cm / 30.70 in

Width: 47 cm / 18.5 in

Depth: 53 cm / 20.86 in

Seat height: 45 cm (wooden seat) / 17.72 in

Upholstered seat is 2cm / 0,78 in higher than wooden seat

Seat size: 45x46cm / 17.72x18.11 in

PACKAGING

Stretch wrap + five-layer cardboard box.

2 pieces

PACKAGING DIMENSIONS

Height: 100 cm / 39.37 in

Width: 50 cm / 19.68 in

Depth: 70 cm / 27.56 in

WEIGHT

Weight: 13 kg

Packaging: 2 kg

WOOD

Oak, American and European walnut, elm, cherry, maple, ash

WOOD FINISHES

Available in a variety of natural oil and soap finishes. Discover more information artisan.ba/materials

UPHOLSTERY

Available in a variety of leathers and fabrics.

More information at artisan.ba/materials

CLEANING INSTRUCTIONS

Please download our material care & cleaning instructions through artisan.ba/materials

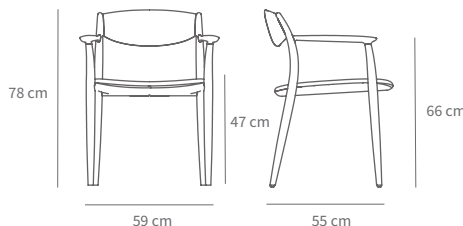

DESCRIPTION

With its gentle curves and honest material expression, Nila is a quietly sophisticated addition to any setting. Its solid wood frame is defined by subtle tapering, a curved backrest, and a refined sense of proportion. Designed for longevity and versatility, Nila's understated elegance works seamlessly across dining spaces, meeting rooms, and contemporary interiors. Explore its versatility further with a choice of solid wood frames in a range of species, and upholstery options in leather or fabric, allowing you to curate the perfect seating solution for your space

PRODUCTION PROCESS

The chair parts are made of solid wood pieces of the same length but different widths, with precisely crafted joints on CNC machines. Each piece is chosen through careful matching of wood colors and structures. The upholstered seats are covered with HR foam and upholstery for superior comfort. Certain chair collections are produced using a special wood bending technology. The technical parameters of hand-assembled chairs comply with standard requirements. Final sanding is done manually with fine-grained sandpaper, and various types of finishes enable a wide selection of the chair's final appearance.

PRODUCT TYPE

Armchair

USAGE

Indoor

DISMANTLING OPTION

No

GLIDERS

Standard gliders

STOCK ITEMS

No

COUNTRY OF ORIGIN

BiH

NOTE

The listed weights are approximate; the weight of each piece depends on the type of wood.

DIMENSIONS

Height: 78 cm / 30.71 in

Width: 59 cm / 23.62 in

Depth: 55 cm / 21.65 in

Seat height: 45 cm (wooden seat) / 17.72 in

Upholstered seat is 2 cm / 0,78 in higher than wooden seat

Seat size: 49x50 cm / 19.29x19.68 in

Armrest height: 66 cm / 25.98 in

PACKAGING

Stretch wrap + five-layer cardboard box.

1 piece

PACKAGING DIMENSIONS

Height: 80 cm / 31.5 in

Width: 65 cm / 25.59 in

Depth: 55 cm / 21.65 in

WEIGHT

Weight: 8.5 kg

Packaging: 1.5 kg

MATERIALS

Oak, American and European walnut, elm, cherry, maple, ash

WOOD FINISHES

Available in a variety of natural oil and soap finishes. Discover more information artisan.ba/materials

UPHOLSTERY

Available in a variety of leathers and fabrics. More information at artisan.ba/materials

CLEANING INSTRUCTIONS

Please download our material care & cleaning instructions through artisan.ba/materials

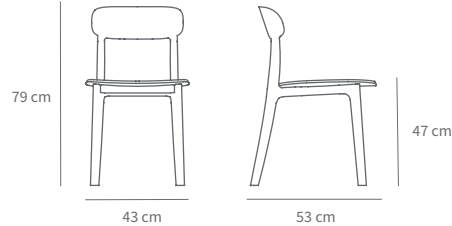

DESCRIPTION

Tanka brings together minimalist lines and natural materiality in a balanced, functional form. The solid wood frame features a slightly reclined backrest and comfortable proportions, making it suited to both formal and casual dining settings. Tanka is designed to disappear into an interior while offering a quiet sense of craft and care. Explore its versatility further with a choice of solid wood frames in a range of species, and upholstery options in leather or fabric, allowing you to curate the perfect seating solution for your space.

PRODUCTION PROCESS

The chair parts are made of solid wood pieces of the same length but different widths, with precisely crafted joints on CNC machines. Each piece is chosen through careful matching of wood colors and structures. The upholstered seats are covered with HR foam and upholstery for superior comfort. Certain chair collections are produced using a special wood bending technology. The technical parameters of hand-assembled chairs comply with standard requirements. Final sanding is done manually with fine-grained sandpaper, and various types of finishes enable a wide selection of the chair's final appearance.

PRODUCT TYPE

Chair

USAGE

Indoor

DISMANTLING OPTION

No

GLIDERS

Standard gliders

STOCK ITEMS

No

COUNTRY OF ORIGIN

BiH

NOTE

The listed weights are approximate; the weight of each piece depends on the type of wood.

DIMENSIONS

Height: 79 cm / 31.10 in

Width: 43 cm / 16.92 in

Depth: 53 cm / 20.87 in

Seat height: 45 cm, (wooden) seat cm / 17.72 in

Upholstered seat is 2 cm / 0,78 in higher than wooden seat

Seat size: 43x43 cm / 16.92x16.92 in

PACKAGING

Stretch wrap + five-layer cardboard box.

2 pieces

PACKAGING DIMENSIONS

Height: 100 cm / 39.37 in

Width: 50 cm / 19.68 in

Depth: 70 cm / 27.56 in

WEIGHT

Weight: 13 kg

Packaging: 2 kg

MATERIALS

Oak, American and European walnut, elm, cherry, maple, ash

WOOD FINISHES

Available in a variety of natural oil and soap finishes. Discover more information artisan.ba/materials

UPHOLSTERY

Available in a variety of leathers and fabrics.

More information at artisan.ba/materials

CLEANING INSTRUCTIONS

Please download our material care & cleaning instructions through artisan.ba/materialsf

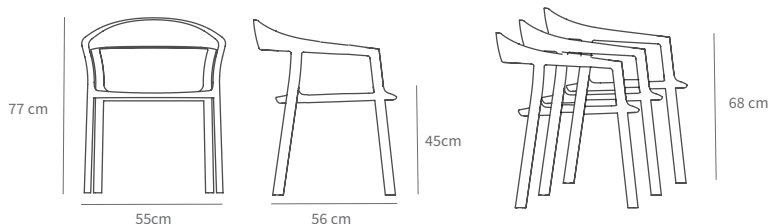

DESCRIPTION

Tara chair exemplifies Artisan's commitment to refined craftsmanship and functional design. Its solid wood frame features a gently curved backrest and integrated armrests, providing ergonomic support within a minimalist silhouette. Available with a solid wood seat or upholstered in a selection of premium fabrics and leathers, Tara can be customised to suit diverse interior aesthetics.

PRODUCTION PROCESS

The chair parts are made of solid wood pieces of the same length but different widths, with precisely crafted joints on CNC machines. Each piece is chosen through careful matching of wood colors and structures. The upholstered seats are covered with HR foam and upholstery for superior comfort. Certain chair collections are produced using a special wood bending technology. The technical parameters of hand-assembled chairs comply with standard requirements. Final sanding is done manually with fine-grained sandpaper, and various types of finishes enable a wide selection of the chair's final appearance.

PRODUCT TYPE

Armchair

USAGE

Indoor

DISMANTLING OPTION

No

GLIDERS

Standard gliders

STOCK ITEMS

No

COUNTRY OF ORIGIN

BiH

NOTE

The listed weights are approximate; the weight of each piece depends on the type of wood.

DIMENSIONS

Height: 77 cm / 30.31 in

Width: 55 cm / 21.65 in

Depth: 56 cm / 22.05 in

Seat height: 45 cm (wooden seat) / 17.72 in

Upholstered seat is 2 cm / 0,78 in higher than wooden seat

Seat size: 42x46cm / 16.53x18.11 in

PACKAGING

Stretch wrap + five-layer cardboard box.

1 piece

PACKAGING DIMENSIONS

Height: 80 cm / 31.5 in

Width: 55 cm / 21.65 in

Depth: 55 cm / 21.65 in

WEIGHT

Weight: 7.5 kg

Packaging: 1.5 kg

MATERIALS

Oak, American and European walnut, elm, cherry, maple, ash

WOOD FINISHES

Available in a variety of natural oil and soap finishes. Discover more information artisan.ba/materials

UPHOLSTERY

Available in a variety of leathers and fabrics.

More information at artisan.ba/materials

CLEANING INSTRUCTIONS

Please download our material care & cleaning instructions through artisan.ba/materials

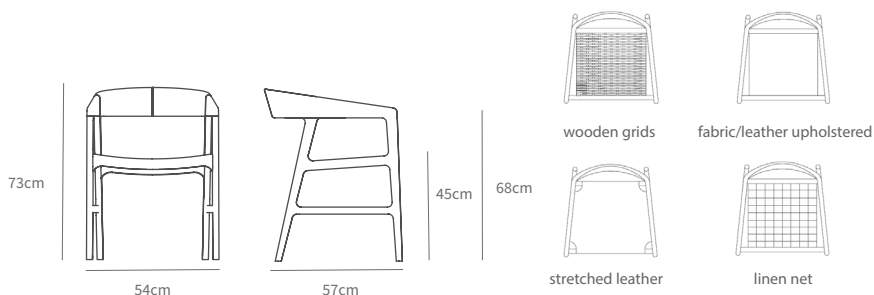

DESCRIPTION

The Tesa chair exemplifies the commitment to design excellence and innovation. Handcrafted with attention to detail, Tesa blends European design aesthetics with functionality, making it perfect for residential and commercial interior design projects. The upholstered seat enhances comfort, while its broad stance and softened angles give the piece quiet confidence. Explore its versatility with seat types including wooden grid, fabric or leather upholstery, stretched leather, and linen net, allowing you to curate the perfect seating solution for your space.

PRODUCTION PROCESS

The chair parts are made of solid wood pieces of the same length but different widths, with precisely crafted joints on CNC machines. Each piece is chosen through careful matching of wood colors and structures. The upholstered seats are covered with HR foam and upholstery for superior comfort. Certain chair collections are produced using a special wood bending technology. The technical parameters of hand-assembled chairs comply with standard requirements. Final sanding is done manually with fine-grained sandpaper, and various types of finishes enable a wide selection of the chair's final appearance.

PRODUCT TYPE

Armchair

USAGE

Indoor

DISMANTLING OPTION

No

GLIDERS

Standard gliders

STOCK ITEMS

No

COUNTRY OF ORIGIN

BiH

NOTE

If it is not defined, intarsia (visible joint in the backrest) will be in the same wood type as chair. The listed weights are approximate; the weight of each piece depends on the type of wood.

DIMENSIONS

Height: 73 cm / 28.74 in

Width: 54 cm / 21.25 in

Depth: 57 cm / 22.44 in

Seat height: 45 cm (wooden seat) / 17.72 in

Upholstered seat is 2 cm / 0,78 in higher than wooden seat

Armrest height: 68 cm / 26.77 in

Seat size: 45x39 cm / 17.71x15.35 in

PACKAGING

Stretch wrap + five-layer cardboard box.

1 piece

PACKAGING DIMENSIONS

Height: 80 cm / 31.5 in

Width: 55 cm / 21.65 in

Depth: 55 cm / 21.65 in

WEIGHT

Weight: 8 kg

Packaging: 1.5 kg

MATERIALS

Oak, American and European walnut, elm, cherry, maple, ash

WOOD FINISHES

Available in a variety of natural oil and soap finishes. More information at artisan.ba/materials

UPHOLSTERY

Available in a variety of leathers and fabrics. More information at artisan.ba/materials

SEAT TYPES

Wooden grids, fabric/leather upholstered, stretched leather, linen net

CLEANING INSTRUCTIONS

Please download our material care & cleaning instructions through artisan.ba/materials

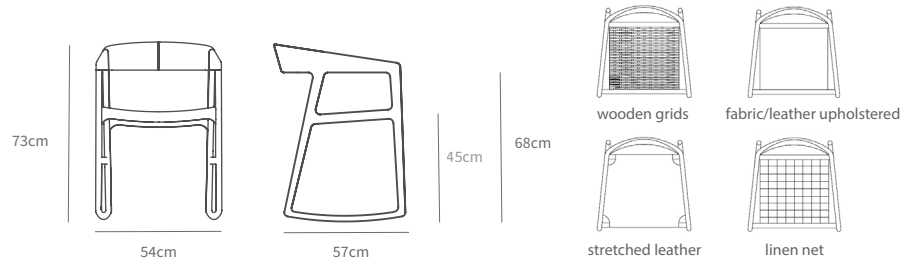

DESCRIPTION

The Tesa rocking chair exemplifies the commitment to design excellence and innovation. Handcrafted with attention to detail, Tesa blends European design aesthetics with functionality, making it perfect for residential and commercial interior design projects. The upholstered seat enhances comfort, while its broad stance and softened angles give the piece quiet confidence. Explore its versatility with seat types including wooden grid, fabric or leather upholstery, stretched leather, and linen net, allowing you to curate the perfect seating solution for your space.

PRODUCTION PROCESS

The chair parts are made of solid wood pieces of the same length but different widths, with precisely crafted joints on CNC machines. Each piece is chosen through careful matching of wood colors and structures. The upholstered seats are covered with HR foam and upholstery for superior comfort. Certain chair collections are produced using a special wood bending technology. The technical parameters of hand-assembled chairs comply with standard requirements. Final sanding is done manually with fine-grained sandpaper, and various types of finishes enable a wide selection of the chair's final appearance.

PRODUCT TYPE

Armchair

USAGE

Indoor

DISMANTLING OPTION

No

GLIDERS

-

STOCK ITEMS

No

COUNTRY OF ORIGIN

BiH

NOTE

If it is not defined, intarsia (visible joint in the backrest) will be in the same wood type as chair. The listed weights are approximate; the weight of each piece depends on the type of wood.

DIMENSIONS

Height: 73 cm / 28.74 in

Width: 54 cm / 21.25 in

Depth: 57 cm / 22.44 in

Seat height: 45 cm (wooden seat) / 17.72 in

Upholstered seat is 2 cm / 0,78 in higher than wooden seat

Armrest height: 68 cm / 26.77 in

Seat size: 40x37 cm / 15.74x14.56 in

PACKAGING

Stretch wrap + five-layer cardboard box.

1 piece

PACKAGING DIMENSIONS

Height: 80 cm / 31.5 in

Width: 55 cm / 21.65 in

Depth: 55 cm / 21.65 in

WEIGHT

Weight: 8 kg

Packaging: 1.5 kg

MATERIALS

Oak, American and European walnut, elm, cherry, maple, ash

WOOD FINISHES

Available in a variety of natural oil and soap finishes. Discover more information artisan.ba/materials

UPHOLSTERY

Available in a variety of leathers and fabrics. More information at artisan.ba/materials

SEAT TYPES

Wooden grids, fabric/leather upholstered, stretched leather, linen net

CLEANING INSTRUCTIONS

Please download our material care & cleaning instructions through artisan.ba/materials

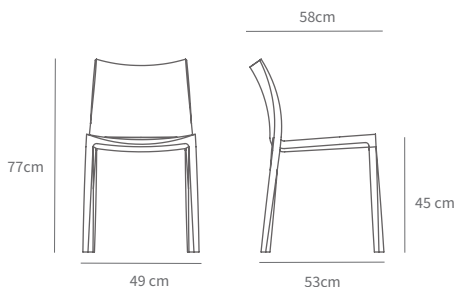

DESCRIPTION

Torsio expresses movement through form, with a backrest that twists gently to provide ergonomic support. Its solid wood construction is shaped with expert precision, revealing soft curves and seamless transitions between elements. Ideal for refined dining interiors, Torsio offers comfort and timeless material beauty. Explore its versatility further with a choice of solid wood frames in a range of species, and upholstery options in leather or fabric, allowing you to curate the perfect seating solution for your space.

PRODUCTION PROCESS

The chair parts are made of solid wood pieces of the same length but different widths, with precisely crafted joints on CNC machines. Each piece is chosen through careful matching of wood colors and structures. The upholstered seats are covered with HR foam and upholstery for superior comfort. Certain chair collections are produced using a special wood bending technology. The technical parameters of hand-assembled chairs comply with standard requirements. Final sanding is done manually with fine-grained sandpaper, and various types of finishes enable a wide selection of the chair's final appearance.

PRODUCT TYPE

Chair

USAGE

Indoor

DISMANTLING OPTION

No

GLIDERS

Standard gliders

STOCK ITEMS

No

COUNTRY OF ORIGIN

BiH

NOTE

The listed weights are approximate; the weight of each piece depends on the type of wood.

DIMENSIONS

Height: 77 cm / 30.31 in

Width: 49 cm / 19.29 in

Depth: 58 cm / 22.83 in

Seat height: 45 cm (wooden seat) / 17.72 in

Upholstered seat is 2 cm / 0,78 in higher than wooden seat

Seat size: 46x39cm / 18.11x15.35 in

PACKAGING

Stretch wrap + five-layer cardboard box.

2/3 pieces

PACKAGING DIMENSIONS

Height: 100 cm / 39.37 in

Width: 50 cm / 19.69 in

Depth: 70 cm / 27.56 in

WEIGHT

Weight: 8.5 kg

Packaging: 1.5 kg

MATERIALS

Oak, American and European walnut, elm, cherry, maple, ash

WOOD FINISHES

Available in a variety of natural oil and soap finishes. Discover more information artisan.ba/materials

UPHOLSTERY

Available in a variety of leathers and fabrics. More information at artisan.ba/materials

CLEANING INSTRUCTIONS

Please download our material care & cleaning instructions through artisan.ba/materials

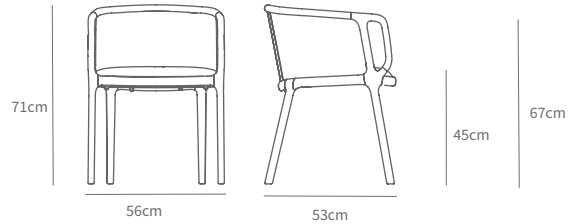

DESCRIPTION

Winner of the prestigious BIG SEE Product Design Award 2024 and German Design Award 2025, the Velo Chair is a testament to timeless furniture design and refined craftsmanship. Explore its versatility further with a choice of solid wood frames in a range of species, and upholstery options in leather or fabric, allowing you to curate the perfect seating solution for your space.

PRODUCTION PROCESS

The chair parts are made of solid wood pieces of the same length but different widths, with precisely crafted joints on CNC machines. Each piece is chosen through careful matching of wood colors and structures. The upholstered seats are covered with HR foam and upholstery for superior comfort. Certain chair collections are produced using a special wood bending technology. The technical parameters of hand-assembled chairs comply with standard requirements. Final sanding is done manually with fine-grained sandpaper, and various types of finishes enable a wide selection of the chair's final appearance.

PRODUCT TYPE

Armchair

USAGE

Indoor

DISMANTLING OPTION

No

GLIDERS

Standard gliders

STOCK ITEMS

No

COUNTRY OF ORIGIN

BiH

NOTE

The listed weights are approximate; the weight of each piece depends on the type of wood.

DIMENSIONS

Height: 70 cm / 27.55 in

Width: 56 cm / 22.05 in

Depth: 52 cm / 20.47 in

Seat height: 45 cm / 17.72 in

Seat size: 49x42cm / 19.2x16.5in

Armrest height: 67 cm / 26.38 in

Armrest width: 3 cm / 1.18 in

PACKAGING

Stretch wrap + five-layer cardboard box.

1 piece

PACKAGING DIMENSIONS

Height: 80 cm / 31.5 in

Width: 55 cm / 21.65 in

Depth: 55 cm / 21.65 in

WEIGHT

Weight: 13.5 kg

Packaging: 1.5 kg

MATERIALS

Oak, American and European walnut, elm, cherry, maple, ash

WOOD FINISHES

Available in a variety of natural oil and soap finishes. Discover more information artisan.ba/materials

UPHOLSTERY

Available in a variety of leathers and fabrics.

More information at artisan.ba/materials

CLEANING INSTRUCTIONS

Please download our material care & cleaning instructions through artisan.ba/materials

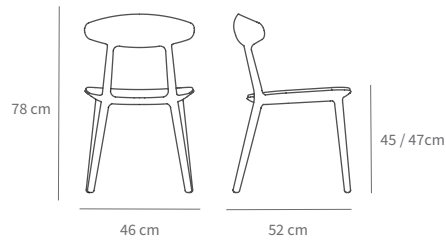

DESCRIPTION

A classic simple form enhanced with a high level of refinement in craftsmanship and extreme fluidity of form; its clearly defined elements seem to flow from and into one another. The oval backrest of minimalist dimensions, ergonomically curved, defines the chair's visual character, functionally accomplished with the same feature seat. These simple elements are connected by equally simple yet strong verticals of a spherical cross-section. The curvature permeates the piece as the dominant design principle, additionally enhanced with the incredible softness of the almost invisible joints, creating an impression of overall compactness, perfect in simplicity. The solid wood chair, without a single sharp edge, appears in a softened version as well, with an upholstered seat and colourful detachment from the raw material, accentuating the beauty of craftsmanship. The high level of material and processing quality translated into an extremely classic form is what makes this chair a desired guest in any space. Unassuming yet visible, it testifies to the users' refined disposition, describing but never unveiling them.

PRODUCTION PROCESS

The chair parts are made of solid wood pieces of the same length but different widths, with precisely crafted joints on CNC machines. Each piece is chosen through careful matching of wood colors and structures. The upholstered seats are covered with HR foam and upholstery for superior comfort. Certain chair collections are produced using a special wood bending technology. The technical parameters of hand-assembled chairs comply with standard requirements. Final sanding is done manually with fine-grained sandpaper, and various types of finishes enable a wide selection of the chair's final appearance.

PRODUCT TYPE

Chair

USAGE

Indoor

DISMANTLING OPTION

No

GLIDERS

Standard gliders

STOCK ITEMS

No

COUNTRY OF ORIGIN

BiH

NOTE

The listed weights are approximate; the weight of each piece depends on the type of wood.

DIMENSIONS

Height: 78 cm / 30.70 in

Width: 44 cm / 17.32 in

Depth: 52 cm / 20.47 in

Seat height: 45 cm (wooden seat) / 17.72 in

Upholstered seat is 2 cm / 0,78 in higher than wooden seat

Seat size: 43x45cm / 16.9x17.7 in

PACKAGING

Stretch wrap + five-layer cardboard box.

1 piece

PACKAGING DIMENSIONS

Height: 100 cm / 39.37 in

Width: 50 cm / 19.68 in

Depth: 70 cm / 27.56 in

WEIGHT

Weight: 8.5 kg

Packaging: 1.5 kg

MATERIALS

Oak, American and European walnut, elm, cherry, maple, ash

WOOD FINISHES

Available in a variety of natural oil and soap finishes. Discover more information artisan.ba/materials

UPHOLSTERY

Available in a variety of leathers and fabrics. More information at artisan.ba/materials

CLEANING INSTRUCTIONS

Please download our material care & cleaning instructions through artisan.ba/materials

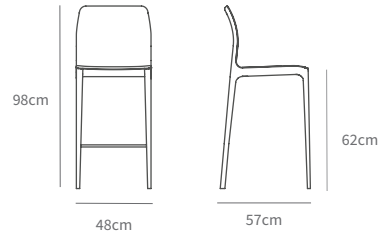

DESCRIPTION

A powerful wood and leather combination is highlighted by simple composition. A robust wooden frame provides the basis for the structure, visually exposed and accentuated in the lower part: the solid legs provide a steady foundation for the upper part, fully upholstered in leather. The leather cloak is an integral compact surface fully covering the backrest, the seat and the wooden structure, without visible edges and seams, underlining the beauty and quality of the material. Covering the wooden structure in leather results in comfort and a clear visual dichotomy between the full and the empty, between the textures of the two essential materials. Carefully paced complementary structures create a visually impressive unit, undoubtedly steady and solid, both unassuming and impressive in space. The Invito chair inspires safety. The powerful volume evokes durability and longevity, ideal for creating a space with a distinct character, however with a dose of visual refinement and attractive comfort.

PRODUCTION PROCESS

The bar chair parts are made of solid wood pieces of the same length but different widths, with precisely crafted joints on CNC machines. Each piece is chosen through careful matching of wood colors and structures. The upholstered seats are covered with HR foam and upholstery for superior comfort. Certain chair collections are produced using a special wood bending technology. The technical parameters of hand-assembled chairs comply with standard requirements. Final sanding is done manually with fine-grained sandpaper, and various types of finishes enable a wide selection of the chair's final appearance.

PRODUCT TYPE

Bar chair

USAGE

Indoor

DISMANTLING OPTION

No

GLIDERS

Standard gliders

STOCK ITEMS

No

COUNTRY OF ORIGIN

BiH

NOTE

The listed weights are approximate; the weight of each piece depends on the type of wood.

DIMENSIONS

Height: 98 cm / 38.58 in
Width: 48 cm / 18.8 in
Depth: 57 cm / 22.44 in
Seat height: 62 cm / 24.41 in
Seat size: 46x46cm / 18.1x18.1 in

PACKAGING

Stretch wrap + five-layer cardboard box.
1 piece

PACKAGING DIMENSIONS

Height: 100 cm / 39.37 in
Width: 50 cm / 23.62 in
Depth: 70 cm / 27.56 in

WEIGHT

Weight: 7 kg
Packaging: 2 kg

MATERIALS

Oak, American and European walnut, elm, cherry, maple, ash

WOOD FINISHES

Available in a variety of natural oil and soap finishes. Discover more information artisan.ba/materials

UPHOLSTERY

Available only in black full grain leather

BASE FINISHES FOR FOOTREST

The footrest can be wooden, black or brass on request. Unless the material is specified brass will be applied.

CLEANING INSTRUCTIONS

Please download our material care & cleaning instructions through artisan.ba/materials

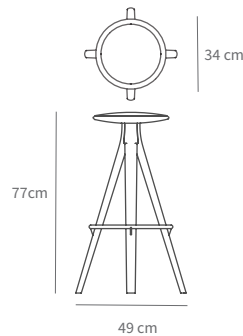

DESCRIPTION

A combination of beauty of the material, the wood basis and ceramic or leather superstructure, is bound in this collection by the common element: a calotte. A subtle association to the spherical form, to a segment of this perfect shape, is immersed in the warmth of wood, in a curved mould, like a negative embracing a body. The piece is completed by a flat surface with a contrasting tone and texture, ceramic or leather inserts, trimmed with wood, like an elegant cross-section, a calotte surface. The functional horizontal place remains visually accentuated by means of the material's aesthetic sensations, textures in seductive light and dark versions, accompanied by the imperative of the tactile, of touch.

PRODUCTION PROCESS

The bar chair parts are made of solid wood pieces of the same length but different widths, with precisely crafted joints on CNC machines. Each piece is chosen through careful matching of wood colors and structures. The upholstered seats are covered with HR foam and upholstery for superior comfort. Certain chair collections are produced using a special wood bending technology. The technical parameters of hand-assembled chairs comply with standard requirements. Final sanding is done manually with fine-grained sandpaper, and various types of finishes enable a wide selection of the chair's final appearance.

PRODUCT TYPE

Bar chair

USAGE

Indoor

DISMANTLING OPTION

No

GLIDERS

Standard gliders

STOCK ITEMS

No

COUNTRY OF ORIGIN

BiH

NOTE

The listed weights are approximate; the weight of each piece depends on the type of wood.

DIMENSIONS

Height: 77cm/ 30.31 in

Width: 49 cm/ 19.29 in

Depth: 49 cm/ 19.29 in

Seat height: 77 cm/ 30.31 in

Seat size: 34cm / 13.38 in

PACKAGING

Stretch wrap + five-layer cardboard box.

1 piece

PACKAGING DIMENSIONS

Height: 85 cm/ 33.46 in

Width: 45 cm/ 17.71 in

Depth: 45 cm/ 17.71 in

WEIGHT

Weight: 7 kg

Packaging: 1.5 kg

MATERIALS

Oak, American and European walnut, elm, cherry, maple, ash

WOOD FINISHES

Available in a variety of natural oil and soap finishes. Discover more information artisan.ba/materials

UPHOLSTERY

Available in a variety of fabrics and leather. More information at artisan.ba/materials

BASE FINISHES FOR FOOTREST

The footrest ring can be black or white. Unless the material is specified black will be applied.

CLEANING INSTRUCTIONS

Please download our material care & cleaning instructions through artisan.ba/materials

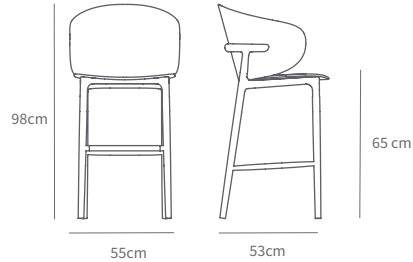

DESCRIPTION

The Mela bar chair features a fully upholstered seat and backrest supported by a solid wood frame. The soft, continuous form provides comfort and support, with careful attention to ergonomic proportion. Available in two seat heights - 65 cm and 79 cm, it can be suited for residential or commercial applications. Explore its versatility further with a choice of solid wood frames in a range of species, and upholstery options in leather or fabric, allowing you to curate the perfect seating solution for your space.

PRODUCTION PROCESS

The bar chair parts are made of solid wood pieces of the same length but different widths, with precisely crafted joints on CNC machines. Each piece is chosen through careful matching of wood colors and structures. The upholstered seats are covered with HR foam and upholstery for superior comfort. Certain chair collections are produced using a special wood bending technology. The technical parameters of hand-assembled chairs comply with standard requirements. Final sanding is done manually with fine-grained sandpaper, and various types of finishes enable a wide selection of the chair's final appearance.

PRODUCT TYPE

Bar chair

USAGE

Indoor

DISMANTLING OPTION

No

GLIDERS

Standard gliders

STOCK ITEMS

No

COUNTRY OF ORIGIN

BiH

NOTE

The listed weights are approximate; the weight of each piece depends on the type of wood.

DIMENSIONS

Height: 98 cm/ 38.58 in
Width: 55 cm/ 21.66 in
Depth: 53 cm/ 20.87 in
Seat height: 65 cm/ 25.59 in
Seat size: 49x43cm / 19.29x16.93 in

PACKAGING

Stretch wrap + five-layer cardboard box.
1 piece

PACKAGING DIMENSIONS

Height: 112 cm/ 44.09 in
Width: 52 cm/ 20.47 in
Depth: 60 cm/ 23.62 in

WEIGHT

Weight: 12 kg
Packaging: 2 kg

MATERIALS

Oak, American and European walnut, elm, cherry, maple, ash

WOOD FINISHES

Available in a variety of natural oil and soap finishes. Discover more information artisan.ba/materials

UPHOLSTERY

Available in a variety of leathers and fabrics. More information at artisan.ba/materials

BASE FINISHES FOR FOOTREST

Wooden footrest.
Inox, brass and powder-coated steel decoration on the footrest is possible on request.

CLEANING INSTRUCTIONS

Please download our material care & cleaning instructions through artisan.ba/materials

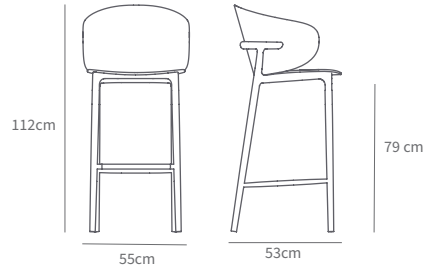

DESCRIPTION

The Mela bar chair features a fully upholstered seat and backrest supported by a solid wood frame. The soft, continuous form provides comfort and support, with careful attention to ergonomic proportion. Available in two seat heights - 65 cm and 79 cm, it can be suited for residential or commercial applications. Explore its versatility further with a choice of solid wood frames in a range of species, and upholstery options in leather or fabric, allowing you to curate the perfect seating solution for your space.

PRODUCTION PROCESS

The bar chair parts are made of solid wood pieces of the same length but different widths, with precisely crafted joints on CNC machines. Each piece is chosen through careful matching of wood colors and structures. The upholstered seats are covered with HR foam and upholstery for superior comfort. Certain chair collections are produced using a special wood bending technology. The technical parameters of hand-assembled chairs comply with standard requirements. Final sanding is done manually with fine-grained sandpaper, and various types of finishes enable a wide selection of the chair's final appearance.

PRODUCT TYPE

Bar chair

USAGE

Indoor

DISMANTLING OPTION

No

GLIDERS

Standard gliders

STOCK ITEMS

No

COUNTRY OF ORIGIN

BiH

NOTE

The listed weights are approximate; the weight of each piece depends on the type of wood.

DIMENSIONS

Height: 112 cm/ 44.09in
Width: 55 cm/ 21.66 in
Depth: 53 cm/ 20.87 in
Seat height: 79 cm/ 31.1 in
Seat size: 49x43cm / 19.29x16.93 in

PACKAGING

Stretch wrap + five-layer cardboard box.
1 piece

PACKAGING DIMENSIONS

Height: 115 cm/ 45.27 in
Width: 52 cm/ 20.47 in
Depth: 60 cm/ 23.62 in

WEIGHT

Weight: 13 kg
Packaging: 2 kg

MATERIALS

Oak, American and European walnut, elm, cherry, maple, ash

WOOD FINISHES

Available in a variety of natural oil and soap finishes. Discover more information artisan.ba/materials

UPHOLSTERY

Available in a variety of leathers and fabrics. More information at artisan.ba/materials

BASE FINISHES FOR FOOTREST

Wooden footrest.
Inox, brass and powder-coated steel decoration on the footrest is possible on request.

CLEANING INSTRUCTIONS

Please download our material care & cleaning instructions through artisan.ba/materials

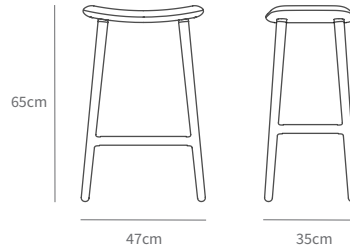

DESCRIPTION

The Naru bar chair embodies the essence of simplicity, comfort, and refined craftsmanship. With its pure, flowing lines and well-balanced proportions, Naru offers an inviting seating experience that feels both natural and sophisticated. The softly contoured seat and ergonomic shape ensure lasting comfort, while the solid wood structure, crafted with Artisan's renowned expertise, adds warmth, strength, and visual lightness. Every curve and connection is carefully considered, creating a piece that seamlessly blends functionality, elegance, and artisanal mastery, perfect for both relaxed and refined environments.

PRODUCTION PROCESS

The bar chair parts are made of solid wood pieces of the same length but different widths, with precisely crafted joints on CNC machines. Each piece is chosen through careful matching of wood colors and structures. The upholstered seats are covered with HR foam and upholstery for superior comfort. Certain chair collections are produced using a special wood bending technology. The technical parameters of hand-assembled chairs comply with standard requirements. Final sanding is done manually with fine-grained sandpaper, and various types of finishes enable a wide selection of the chair's final appearance.

PRODUCT TYPE

Bar chair

USAGE

Indoor

DISMANTLING OPTION

No

GLIDERS

Standard gliders

STOCK ITEMS

No

COUNTRY OF ORIGIN

BiH

NOTE

The listed weights are approximate; the weight of each piece depends on the type of wood.

DIMENSIONS

Height: 65 cm / 25.59 in
Width: 47 cm / 18.5 in
Depth: 35 cm / 13.77 in
Seat height: 65 cm / 25.59 in
Seat size: 42x31cm / 16.54x12.20 in

PACKAGING

Stretch wrap + five-layer cardboard box.
1 piece

PACKAGING DIMENSIONS

Height: 70 cm / 27.55 in
Width: 45 cm / 17.71 in
Depth: 45cm / 17.71 in

WEIGHT

Weight: 5 kg
Packaging: 1.5 kg

MATERIALS

Oak, American and European walnut, elm, cherry, maple, ash

WOOD FINISHES

Available in a variety of natural oil and soap finishes. Discover more information artisan.ba/materials

UPHOLSTERY

Available in a variety of leathers and fabrics. More information at artisan.ba/materials

FOOTREST

Wooden footrest.
Inox, brass and powder-coated steel decoration on the footrest is possible on request.

DECORATION RINGS FINISHES

Inox, Brass, Powder-coated steel rings on request

CLEANING INSTRUCTIONS

Please download our material care & cleaning instructions through artisan.ba/materials

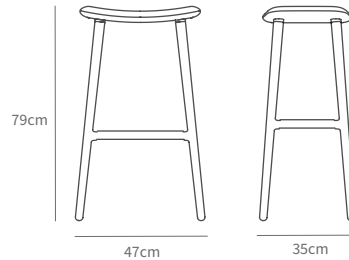

DESCRIPTION

The Naru bar chair embodies the essence of simplicity, comfort, and refined craftsmanship. With its pure, flowing lines and well-balanced proportions, Naru offers an inviting seating experience that feels both natural and sophisticated. The softly contoured seat and ergonomic shape ensure lasting comfort, while the solid wood structure, crafted with Artisan's renowned expertise, adds warmth, strength, and visual lightness. Every curve and connection is carefully considered, creating a piece that seamlessly blends functionality, elegance, and artisanal mastery, perfect for both relaxed and refined environments.

PRODUCTION PROCESS

The bar chair parts are made of solid wood pieces of the same length but different widths, with precisely crafted joints on CNC machines. Each piece is chosen through careful matching of wood colors and structures. The upholstered seats are covered with HR foam and upholstery for superior comfort. Certain chair collections are produced using a special wood bending technology. The technical parameters of hand-assembled chairs comply with standard requirements. Final sanding is done manually with fine-grained sandpaper, and various types of finishes enable a wide selection of the chair's final appearance.

PRODUCT TYPE

Bar chair

USAGE

Indoor

DISMANTLING OPTION

No

GLIDERS

Standard gliders

STOCK ITEMS

No

COUNTRY OF ORIGIN

BiH

NOTE

The listed weights are approximate; the weight of each piece depends on the type of wood.

DIMENSIONS

Height: 79 cm / 31.1 in
Width: 47 cm / 18.5 in
Depth: 35 cm / 13.77 in
Seat height: 65 cm / 25.59 in
Seat size: 42x31cm / 16.54x12.20 in

PACKAGING

Stretch wrap + five-layer cardboard box.
1 piece

PACKAGING DIMENSIONS

Height: 80 cm / 31.49 in
Width: 45 cm / 17.71 in
Depth: 45 cm / 17.71 in

WEIGHT

Weight: 6 kg
Packaging: 1.5 kg

MATERIALS

Oak, American and European walnut, elm, cherry, maple, ash

WOOD FINISHES

Available in a variety of natural oil and soap finishes. Discover more information artisan.ba/materials

UPHOLSTERY

Available in a variety of leathers and fabrics. More information at artisan.ba/materials

FOOTREST

Wooden footrest.
Inox, brass and powder-coated steel decoration on the footrest is possible on request.

DECORATION RINGS FINISHES

Inox, Brass, Powder-coated steel rings on request

CLEANING INSTRUCTIONS

Please download our material care & cleaning instructions through artisan.ba/materials

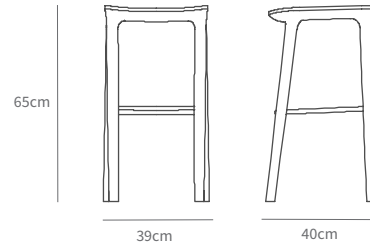

DESCRIPTION

Celebrate the Neva collection's accolades, including the prestigious German Design Award Special Mention, Design Intelligence Award, and Restaurant & Bar Product Design Award. Launched in 2013 with the Neva bar chair, this collection has consistently ranked among Artisan's best-sellers, evolving each year with the introduction of new products. In 2015, the Neva chair made its debut at IMM Cologne, marking a significant addition to this beloved collection. The Neva bar chair offers unparalleled versatility. Choose between a solid wood seat or the luxurious comfort of upholstery, available in a range of premium leathers or fabrics. The footrest can be customised with a RAL powder-coated finish in black or white, or opt for custom materials of aged brass or inox upon request. Elevate your space with the Neva bar chair, a masterpiece of style and functionality that has garnered recognition and acclaim in the world of design.

PRODUCTION PROCESS

The bar chair parts are made of solid wood pieces of the same length but different widths, with precisely crafted joints on CNC machines. Each piece is chosen through careful matching of wood colors and structures. The upholstered seats are covered with HR foam and upholstery for superior comfort. Certain chair collections are produced using a special wood bending technology. The technical parameters of hand-assembled chairs comply with standard requirements. Final sanding is done manually with fine-grained sandpaper, and various types of finishes enable a wide selection of the chair's final appearance.

PRODUCT TYPE

Bar chair

USAGE

Indoor

DISMANTLING OPTION

No

GLIDERS

Standard gliders

STOCK ITEMS

No

COUNTRY OF ORIGIN

BiH

NOTE

The listed weights are approximate; the weight of each piece depends on the type of wood.

DIMENSIONS

Height: 65 cm/ 25.59 in
Width: 39 cm/ 15.35 in
Depth: 40 cm/ 15.75 in
Seat height: 65 cm/ 25.59 in
Seat size: 38x40cm / 14.96x15.75 in

PACKAGING

Stretch wrap + five-layer cardboard box.
1 piece

PACKAGING DIMENSIONS

Height: 70 cm/ 27.55 in
Width: 45 cm/ 17.71 in
Depth: 45 cm/ 17.71 in

WEIGHT

Weight: 6 kg
Packaging: 1.5 kg

MATERIALS

Oak, American and European walnut, elm, cherry, maple, ash

WOOD FINISHES

Available in a variety of natural oil and soap finishes. Discover more information artisan.ba/materials

UPHOLSTERY

Available in a variety of leathers and fabrics. More information at artisan.ba/materials

BASE FINISHES FOR FOOTREST

The footrest can be inox, brass, black or white. Unless the color is specified black color will be applied.

CLEANING INSTRUCTIONS

Please download our material care & cleaning instructions through artisan.ba/materials

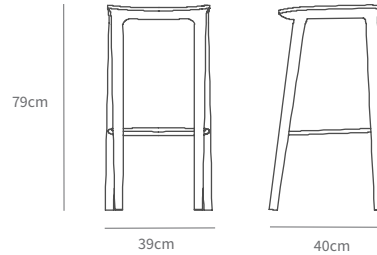

DESCRIPTION

Celebrate the Neva collection's accolades, including the prestigious German Design Award Special Mention, Design Intelligence Award, and Restaurant & Bar Product Design Award. Launched in 2013 with the Neva bar chair, this collection has consistently ranked among Artisan's best-sellers, evolving each year with the introduction of new products. In 2015, the Neva chair made its debut at IMM Cologne, marking a significant addition to this beloved collection. The Neva bar chair offers unparalleled versatility. Choose between a solid wood seat or the luxurious comfort of upholstery, available in a range of premium leathers or fabrics. The footrest can be customised with a RAL powder-coated finish in black or white, or opt for custom materials of aged brass or inox upon request. Elevate your space with the Neva bar chair, a masterpiece of style and functionality that has garnered recognition and acclaim in the world of design.

PRODUCTION PROCESS

The bar chair parts are made of solid wood pieces of the same length but different widths, with precisely crafted joints on CNC machines. Each piece is chosen through careful matching of wood colors and structures. The upholstered seats are covered with HR foam and upholstery for superior comfort. Certain chair collections are produced using a special wood bending technology. The technical parameters of hand-assembled chairs comply with standard requirements. Final sanding is done manually with fine-grained sandpaper, and various types of finishes enable a wide selection of the chair's final appearance.

PRODUCT TYPE

Bar chair

USAGE

Indoor

DISMANTLING OPTION

No

GLIDERS

Standard gliders

STOCK ITEMS

No

COUNTRY OF ORIGIN

BiH

NOTE

The listed weights are approximate; the weight of each piece depends on the type of wood.

DIMENSIONS

Height: 79 cm/ 31.10 in
Width: 39 cm/ 15.35 in
Depth: 40 cm/ 15.75 in
Seat height: 65 cm/ 25.59 in
Seat size: 38x40cm / 14.96x15.75 in

PACKAGING

Stretch wrap + five-layer cardboard box.
1 piece

PACKAGING DIMENSIONS

Height: 80 cm/ 31.49 in
Width: 45 cm/ 17.71 in
Depth: 45 cm/ 17.71 in

WEIGHT

Weight: 8.5 kg
Packaging: 1.5 kg

MATERIALS

Oak, American and European walnut, elm, cherry, maple, ash

WOOD FINISHES

Available in a variety of natural oil and soap finishes. Discover more information artisan.ba/materials

UPHOLSTERY

Available in a variety of leathers and fabrics. More information at artisan.ba/materials

BASE FINISHES FOR FOOTREST

The footrest can be inox, brass, black or white. Unless the color is specified black color will be applied.

CLEANING INSTRUCTIONS

Please download our material care & cleaning instructions through artisan.ba/materials

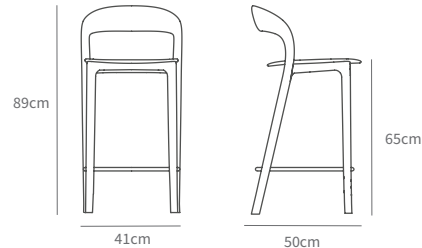

DESCRIPTION

The Neva light bar chair, a testament to timeless elegance and classic design, where a sensuous and fluid form is beautifully realised through soft, angular edges and seamless transitions. Remarkably thin and lightweight, each Neva light bar chair is a masterpiece of meticulous hand-finishing by seasoned craftsmen. Personalise your bar chair with a choice between a solid wood seat or the comfort of upholstery, available in a range of premium leathers or fabrics. For added customisation, the footrest can be tailored with a RAL powder-coated finish in black or white, or opt for custom materials of aged brass or inox upon request. Elevate your space with the Neva light bar chair, where style meets comfort and craftsmanship meets artistry, delivering an unparalleled seating experience.

PRODUCTION PROCESS

The bar chair parts are made of solid wood pieces of the same length but different widths, with precisely crafted joints on CNC machines. Each piece is chosen through careful matching of wood colors and structures. The upholstered seats are covered with HR foam and upholstery for superior comfort. Certain chair collections are produced using a special wood bending technology. The technical parameters of hand-assembled chairs comply with standard requirements. Final sanding is done manually with fine-grained sandpaper, and various types of finishes enable a wide selection of the chair's final appearance.

PRODUCT TYPE

Bar chair

USAGE

Indoor

DISMANTLING OPTION

No

GLIDERS

Standard gliders

STOCK ITEMS

No

COUNTRY OF ORIGIN

BiH

NOTE

The listed weights are approximate; the weight of each piece depends on the type of wood.

DIMENSIONS

Height: 89 cm/ 35.04 in
Width: 41 cm/ 16.14 in
Depth: 50 cm/ 19.69 in
Seat height: 65 cm/ 25.59 in
Seat size: 40x40cm / 15.75x15.75 in

PACKAGING

Stretch wrap + five-layer cardboard box.
1 piece

PACKAGING DIMENSIONS

Height: 90 cm/ 35.43 in
Width: 45 cm/ 17.71 in
Depth: 50 cm/ 19.69 in

WEIGHT

Weight: 8 kg
Packaging: 1.5 kg

MATERIALS

Oak, American and European walnut, elm, cherry, maple, ash

WOOD FINISHES

Available in a variety of natural oil and soap finishes. Discover more information artisan.ba/materials

UPHOLSTERY

Available in a variety of leathers and fabrics. More information at artisan.ba/materials

BASE FINISHES FOR FOOTREST

The footrest can be inox, brass, black or white. Unless the color is specified black color will be applied.

CLEANING INSTRUCTIONS

Please download our material care & cleaning instructions through artisan.ba/materials

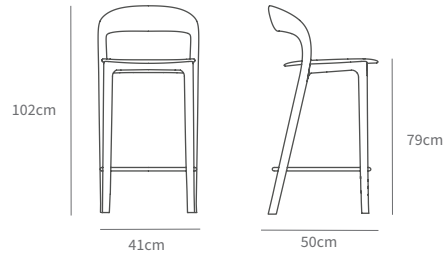

DESCRIPTION

The Neva light bar chair, a testament to timeless elegance and classic design, where a sensuous and fluid form is beautifully realised through soft, angular edges and seamless transitions. Remarkably thin and lightweight, each Neva light bar chair is a masterpiece of meticulous hand-finishing by seasoned craftsmen. Personalise your bar chair with a choice between a solid wood seat or the comfort of upholstery, available in a range of premium leathers or fabrics. For added customisation, the footrest can be tailored with a RAL powder-coated finish in black or white, or opt for custom materials of aged brass or inox upon request. Elevate your space with the Neva light bar chair, where style meets comfort and craftsmanship meets artistry, delivering an unparalleled seating experience.

PRODUCTION PROCESS

The bar chair parts are made of solid wood pieces of the same length but different widths, with precisely crafted joints on CNC machines. Each piece is chosen through careful matching of wood colors and structures. The upholstered seats are covered with HR foam and upholstery for superior comfort. Certain chair collections are produced using a special wood bending technology. The technical parameters of hand-assembled chairs comply with standard requirements. Final sanding is done manually with fine-grained sandpaper, and various types of finishes enable a wide selection of the chair's final appearance.

PRODUCT TYPE

Bar chair

USAGE

Indoor

DISMANTLING OPTION

No

GLIDERS

Standard gliders

STOCK ITEMS

No

COUNTRY OF ORIGIN

BiH

NOTE

The listed weights are approximate; the weight of each piece depends on the type of wood.

DIMENSIONS

Height: 102 cm/ 40.16 in
Width: 41 cm/ 16.14 in
Depth: 50 cm/ 19.69 in
Seat height: 79 cm/ 31.10 in
Seat size: 40x40cm / 15.75x15.75 in

PACKAGING

Stretch wrap + five-layer cardboard box.
1 piece

PACKAGING DIMENSIONS

Height: 105 cm/ 41.33 in
Width: 45 cm/ 17.71 in
Depth: 50 cm/ 19.69 in

WEIGHT

Weight: 8 kg
Packaging: 1.5 kg

MATERIALS

Oak, American and European walnut, elm, cherry, maple, ash

WOOD FINISHES

Available in a variety of natural oil and soap finishes. Discover more information artisan.ba/materials

UPHOLSTERY

Available in a variety of leathers and fabrics. More information at artisan.ba/materials

BASE FINISHES FOR FOOTREST

The footrest can be inox, brass, black or white. Unless the color is specified black color will be applied.

CLEANING INSTRUCTIONS

Please download our material care & cleaning instructions through artisan.ba/materials

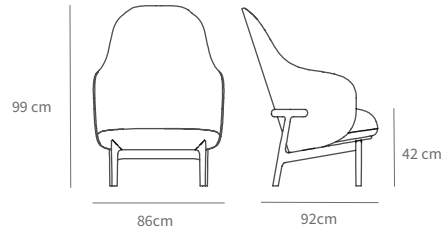

DESCRIPTION

The Mela lounge collection combines timeless elegance of mid-century design with modern comfort, featuring a thoughtfully curated sofa, lounge chair, daybed and ottoman. Each design combines a beautifully crafted wood structure with soft, upholstered seating to create a perfect harmony of style, durability, and relaxation. Sustainably made to meet the needs of both commercial and residential projects, the Mela collection is ideal for diverse environments where aesthetics and functionality are essential.

PRODUCTION PROCESS

The wooden parts of the armchair sofa are made of solid wood pieces of the same length but different widths, with precisely crafted joints produced on CNC machines. Each piece is chosen through careful matching of wood colors and structures. The upholstered seats are covered with HR foam and upholstery for superior comfort. The technical parameters of hand-assembled chairs comply with standard requirements. Final sanding is done manually with fine-grained sandpaper, and various types of finishes enable a wide selection of the chair's final appearance.

PRODUCT TYPE

Lounge chair

USAGE

Indoor

DISMANTLING OPTION

No

GLIDERS

Standard gliders

STOCK ITEMS

No

COUNTRY OF ORIGIN

BiH

NOTE

The listed weights are approximate; the weight of each piece depends on the type of wood.

DIMENSIONS

Height: 99 cm / 38.97 in
Width: 86 cm / 33.85 in
Depth: 92 cm / 36.22 in
Seat height: 42 cm / 16.53 in
Seat size: 81x57 cm / 31.89x22.44 in

PACKAGING

Stretch wrap + five-layer cardboard box.
1 piece

PACKAGING DIMENSIONS

Height: 105 cm / 41.33 in
Width: 97 cm / 38.18 in
Depth: 87 cm / 34.25 in

WEIGHT

Weight: 30 kg
Packaging: 3 kg

MATERIALS

Oak, American and European walnut, elm, cherry, maple, ash

WOOD FINISHES

Available in a variety of natural oil and soap finishes. Discover more information artisan.ba/materials

UPHOLSTERY

Available in a variety of leathers and fabrics. More information at artisan.ba/materials

CLEANING INSTRUCTIONS

Please download our material care & cleaning instructions through artisan.ba/materials

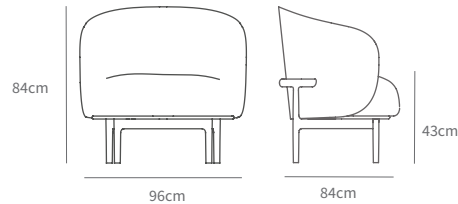

DESCRIPTION

The Mela lounge collection combines timeless elegance of mid-century design with modern comfort, featuring a thoughtfully curated sofa, lounge chair, daybed and ottoman. Each design combines a beautifully crafted wood structure with soft, upholstered seating to create a perfect harmony of style, durability, and relaxation. Sustainably made to meet the needs of both commercial and residential projects, the Mela collection is ideal for diverse environments where aesthetics and functionality are essential.

PRODUCTION PROCESS

The wooden parts of the armchair sofa are made of solid wood pieces of the same length but different widths, with precisely crafted joints produced on CNC machines. Each piece is chosen through careful matching of wood colors and structures. The upholstered seats are covered with HR foam and upholstery for superior comfort. The technical parameters of hand-assembled chairs comply with standard requirements. Final sanding is done manually with fine-grained sandpaper, and various types of finishes enable a wide selection of the chair's final appearance.

PRODUCT TYPE

Lounge chair

USAGE

Indoor

DISMANTLING OPTION

No

GLIDERS

Standard gliders

STOCK ITEMS

No

COUNTRY OF ORIGIN

BiH

NOTE

The listed weights are approximate; the weight of each piece depends on the type of wood.

DIMENSIONS

Height: 84cm/ 33.07 in
Width: 96 cm/ 37.79in
Depth: 84 cm/ 33.07 in
Seat height: 43 cm/ 16.92 in
Seat size: 95x74cm / 37.4x29.13 in

PACKAGING

Stretch wrap + five-layer cardboard box.
1 piece

PACKAGING DIMENSIONS

Height: 90 cm/ 35.43 in
Width: 97 cm/ 38.18 in
Depth: 77 cm/ 30.31 in

WEIGHT

Weight: 33.5 kg
Packaging: 2 kg

MATERIALS

Oak, American and European walnut, elm, cherry, maple, ash

WOOD FINISHES

Available in a variety of natural oil and soap finishes. Discover more information artisan.ba/materials

UPHOLSTERY

Available in a variety of leathers and fabrics. More information at artisan.ba/materials

CLEANING INSTRUCTIONS

Please download our material care & cleaning instructions through artisan.ba/materials

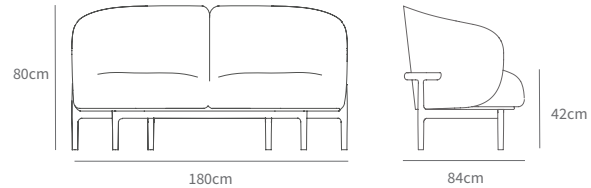

DESCRIPTION

The Mela lounge collection combines timeless elegance of mid-century design with modern comfort, featuring a thoughtfully curated sofa, lounge chair, daybed and ottoman. Each design combines a beautifully crafted wood structure with soft, upholstered seating to create a perfect harmony of style, durability, and relaxation. Sustainably made to meet the needs of both commercial and residential projects, the Mela collection is ideal for diverse environments where aesthetics and functionality are essential.

PRODUCTION PROCESS

The wooden parts of the armchair sofa are made of solid wood pieces of the same length but different widths, with precisely crafted joints produced on CNC machines. Each piece is chosen through careful matching of wood colors and structures. The upholstered seats are covered with HR foam and upholstery for superior comfort. The technical parameters of hand-assembled chairs comply with standard requirements. Final sanding is done manually with fine-grained sandpaper, and various types of finishes enable a wide selection of the chair's final appearance.

PRODUCT TYPE

Sofa

USAGE

Indoor

DISMANTLING OPTION

No

GLIDERS

Standard gliders

STOCK ITEMS

No

COUNTRY OF ORIGIN

BiH

NOTE

The listed weights are approximate; the weight of each piece depends on the type of wood.

DIMENSIONS

Height: 80 cm / 31.49 in
Width: 180 cm / 70.08 in
Depth: 84 cm / 32.68 in
Seat height: 42 cm / 16.53 in
Seat size: 174x74cm / 68.5x29.13 in

PACKAGING

Stretch wrap + five-layer cardboard box.
1 piece

PACKAGING DIMENSIONS

Height: 85 cm / 33.46 in
Width: 195 cm / 76.77 in
Depth: 95 cm / 37.40 in

WEIGHT

Weight: 60 kg
Packaging: 10kg

MATERIALS

Oak, American and European walnut, elm, cherry, maple, ash

WOOD FINISHES

Available in a variety of natural oil and soap finishes. Discover more information artisan.ba/materials

UPHOLSTERY

Available in a variety of leathers and fabrics. More information at artisan.ba/materials

CLEANING INSTRUCTIONS

Please download our material care & cleaning instructions through artisan.ba/materials

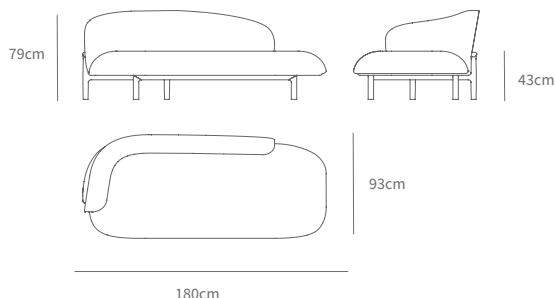

DESCRIPTION

The Mela lounge collection combines timeless elegance of mid-century design with modern comfort, featuring a thoughtfully curated sofa, lounge chair, daybed and ottoman. Each design combines a beautifully crafted wood structure with soft, upholstered seating to create a perfect harmony of style, durability, and relaxation. Sustainably made to meet the needs of both commercial and residential projects, the Mela collection is ideal for diverse environments where aesthetics and functionality are essential.

PRODUCTION PROCESS

The wooden parts of the daybed are made of solid wood pieces of the same length but different widths, with precisely crafted joints produced on CNC machines. Each piece is chosen through careful matching of wood colors and structures. The upholstered seats are covered with HR foam and upholstery for superior comfort. The technical parameters of hand-assembled chairs comply with standard requirements. Final sanding is done manually with fine-grained sandpaper, and various types of finishes enable a wide selection of the chair's final appearance.

PRODUCT TYPE

Daybed

USAGE

Indoor

DISMANTLING OPTION

No

GLIDERS

Standard Gliders

STOCK ITEMS

No

COUNTRY OF ORIGIN

BiH

NOTE

Mega lengths and between sizes possible.
Other modifications and prices on request.
The listed weights are approximate; the weight of each piece depends on its dimensions and the type of wood.

DIMENSIONS

Height: 79 cm/ 31.1 in
Width: 180 cm/ 70.87 in
Depth: 93 cm/ 36.61 in
Seat height: 43 cm/ 16.93 in
Seat size: 160x76 cm / 62.99x29.92 in

PACKAGING

Stretch wrap + five-layer cardboard box.
1 piece

PACKAGING DIMENSIONS

Height: 85 cm/ 33.46 in
Width: 195 cm/ 76.77 in
Depth: 95 cm/ 37.40 in

WEIGHT

Weight: 7 kg
Packaging: 8.5 kg

MATERIALS

Oak, American and European walnut, elm, cherry, maple, ash

WOOD FINISHES

Available in a variety of natural oil and soap finishes. Discover more information artisan.ba/materials

UPHOLSTERY

Available in a variety of leathers and fabrics.
More information at artisan.ba/materials

CLEANING INSTRUCTIONS

Please download our material care & cleaning instructions through artisan.ba/materials

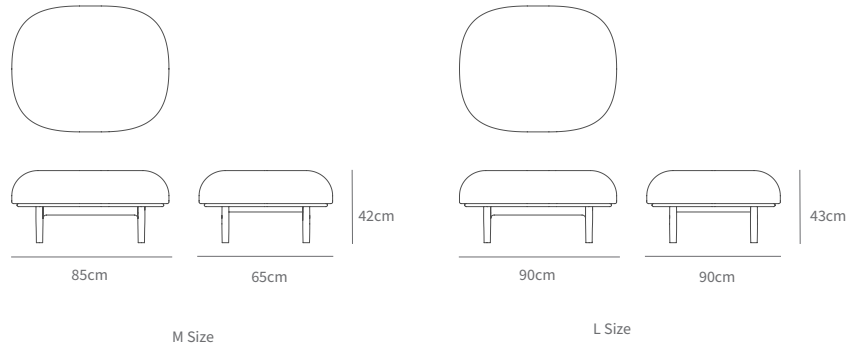

DESCRIPTION

The Mela lounge collection combines timeless elegance of mid-century design with modern comfort, featuring a thoughtfully curated sofa, lounge chair, daybed and ottoman. Each design combines a beautifully crafted wood structure with soft, upholstered seating to create a perfect harmony of style, durability, and relaxation. Sustainably made to meet the needs of both commercial and residential projects, the Mela collection is ideal for diverse environments where aesthetics and functionality are essential.

PRODUCTION PROCESS

The wooden parts of the ottoman are made of solid wood pieces of the same length but different widths, with precisely crafted joints produced on CNC machines. Each piece is chosen through careful matching of wood colors and structures. The upholstered seats are covered with HR foam and upholstery for superior comfort. The technical parameters of hand-assembled chairs comply with standard requirements. Final sanding is done manually with fine-grained sandpaper, and various types of finishes enable a wide selection of the chair's final appearance.

PRODUCT TYPE

Ottoman

USAGE

Indoor

DISMANTLING OPTION

No

GLIDERS

Standard Gliders

STOCK ITEMS

No

COUNTRY OF ORIGIN

BiH

NOTE

The listed weights are approximate; the weight of each piece depends on its dimension and the type of wood.

DIMENSIONS

Height: M 42 cm, L 43cm / 16.53, 16.92 in
Width: M 85 cm, L 90 cm / 33.46, 35.43 in
Depth: M 65 cm, L 90 cm / 25.59, 35.43 in
Seat height: M 42 cm, L 42 cm / 16.54 in
Seat size: M 79x60cm L 86x85 / 31.1x23.62, 33.89x 33.46 in

PACKAGING

Stretch wrap + five-layer cardboard box.
1 piece

PACKAGING DIMENSIONS

Height: 110 cm / 43.31 in
Width: 75-95 cm / 37.4 in
Depth: 100 cm / 39.37 in

WEIGHT

Weight: 12 kg
Packaging: 2 kg

MATERIALS

Oak, American and European walnut, elm, cherry, maple, ash

WOOD FINISHES

Available in a variety of natural oil and soap finishes. Discover more information artisan.ba/materials

UPHOLSTERY

Available in a variety of leathers and fabrics. More information at artisan.ba/materials

CLEANING INSTRUCTIONS

Please download our material care & cleaning instructions through artisan.ba/materials

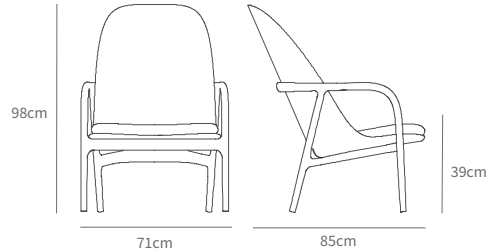

DESCRIPTION

The Neva lounge collection designed by Regular Company is a refined study in the natural elegance of wood. Defined by flowing lines and organic curves, each piece showcases the warmth, grain, and tactile richness of solid wood - inviting a deeper connection to material and form. The collection comprises a lounge chair, two-seater sofa, and ottoman, each available with a low or high backrest. Designed for comfort and visual balance, Neva pairs sculpted wood frames with upholstered seating to suit both residential and commercial environments. Explore its versatility further with a choice of seven solid wood types and upholstery options in premium leathers or fabrics.

PRODUCTION PROCESS

The wooden parts of the armchair sofa are made of solid wood pieces of the same length but different widths, with precisely crafted joints produced on CNC machines. Each piece is chosen through careful matching of wood colors and structures. The upholstered seats are covered with HR foam and upholstery for superior comfort. The technical parameters of hand-assembled chairs comply with standard requirements. Final sanding is done manually with fine-grained sandpaper, and various types of finishes enable a wide selection of the chair's final appearance.

PRODUCT TYPE

Lounge chair

USAGE

Indoor

DISMANTLING OPTION

No

GLIDERS

Standard gliders

STOCK ITEMS

No

COUNTRY OF ORIGIN

BiH

NOTE

The listed weights are approximate; the weight of each piece depends on the type of wood.

DIMENSIONS

Height: 98 cm / 38.58 in
Width: 71 cm / 27.95 in
Depth: 85 cm / 33.46 in
Seat height: 39 cm / 15.35 in
Seat size: 62x56cm / 24.40x22.04in

PACKAGING

Stretch wrap + five-layer cardboard box.
1 piece

PACKAGING DIMENSIONS

Height: 105 cm / 41.33 in
Width: 85 cm / 33.46 in
Depth: 75 cm / 29.52 in

WEIGHT

Weight: 20 kg
Packaging: 3 kg

MATERIALS

Oak, American and European walnut, elm, cherry, maple, ash

WOOD FINISHES

Available in a variety of natural oil and soap finishes. Discover more information artisan.ba/materials

UPHOLSTERY

Available in a variety of leathers and fabrics. More information at artisan.ba/materials

CLEANING INSTRUCTIONS

Please download our material care & cleaning instructions through artisan.ba/materials

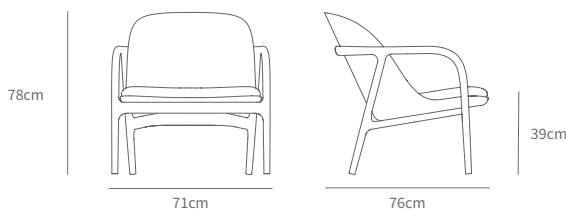

DESCRIPTION

The Neva lounge collection designed by Regular Company is a refined study in the natural elegance of wood. Defined by flowing lines and organic curves, each piece showcases the warmth, grain, and tactile richness of solid wood - inviting a deeper connection to material and form. The collection comprises a lounge chair, two-seater sofa, and ottoman, each available with a low or high backrest. Designed for comfort and visual balance, Neva pairs sculpted wood frames with upholstered seating to suit both residential and commercial environments. Explore its versatility further with a choice of seven solid wood types and upholstery options in premium leathers or fabrics.

PRODUCTION PROCESS

The wooden parts of the armchair sofa are made of solid wood pieces of the same length but different widths, with precisely crafted joints produced on CNC machines. Each piece is chosen through careful matching of wood colors and structures. The upholstered seats are covered with HR foam and upholstery for superior comfort. The technical parameters of hand-assembled chairs comply with standard requirements. Final sanding is done manually with fine-grained sandpaper, and various types of finishes enable a wide selection of the chair's final appearance.

PRODUCT TYPE

Lounge chair

USAGE

Indoor

DISMANTLING OPTION

No

GLIDERS

Standard gliders

STOCK ITEMS

No

COUNTRY OF ORIGIN

BiH

NOTE

The listed weights are approximate; the weight of each piece depends on the type of wood.

DIMENSIONS

Height: 78 cm/ 29.1 in

Width: 71 cm/27.9 in

Depth: 76 cm/29.9in

Seat height: 39 cm/ 15.35 in

Seat size: 62x56cm /24.40x22.04in

PACKAGING

Stretch wrap + five-layer cardboard box.

1 piece

PACKAGING DIMENSIONS

Height: 85 cm/ 33.46 in

Width: 75 cm/ 29.52 in

Depth: 85 cm/ 33.46 in

WEIGHT

Weight: 17 kg

Packaging: 3 kg

MATERIALS

Oak, American and European walnut, elm, cherry, maple, ash

WOOD FINISHES

Available in a variety of natural oil and soap finishes. Discover more information artisan.ba/materials

UPHOLSTERY

Available in a variety of leathers and fabrics.

More information at artisan.ba/materials

CLEANING INSTRUCTIONS

Please download our material care & cleaning instructions through artisan.ba/materials

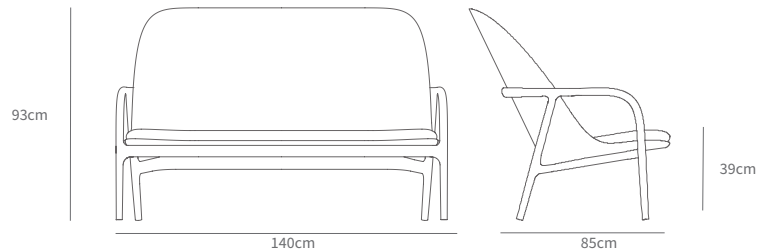

DESCRIPTION

The Neva lounge collection designed by Regular Company is a refined study in the natural elegance of wood. Defined by flowing lines and organic curves, each piece showcases the warmth, grain, and tactile richness of solid wood - inviting a deeper connection to material and form. The collection comprises a lounge chair, two-seater sofa, and ottoman, each available with a low or high backrest. Designed for comfort and visual balance, Neva pairs sculpted wood frames with upholstered seating to suit both residential and commercial environments. Explore its versatility further with a choice of seven solid wood types and upholstery options in premium leathers or fabrics.

PRODUCTION PROCESS

The wooden parts of the sofa are made of solid wood pieces of the same length but different widths, with precisely crafted joints produced on CNC machines. Each piece is chosen through careful matching of wood colors and structures. The upholstered seats are covered with HR foam and upholstery for superior comfort. The technical parameters of hand-assembled chairs comply with standard requirements. Final sanding is done manually with fine-grained sandpaper, and various types of finishes enable a wide selection of the chair's final appearance.

PRODUCT TYPE

Lounge sofa

USAGE

Indoor

DISMANTLING OPTION

No

GLIDERS

Standard gliders

STOCK ITEMS

No

COUNTRY OF ORIGIN

BiH

NOTE

The listed weights are approximate; the weight of each piece depends on the type of wood.

DIMENSIONS

Height: 93 cm / 36.61 in
Width: 140 cm / 55.12 in
Depth: 85 cm / 33.46 in
Seat height: 39 cm / 15.35 in
Seat size: 133x56cm / 52.36x22.04 in

PACKAGING

Stretch wrap + five-layer cardboard box.
1 piece

PACKAGING DIMENSIONS

Height: 105 cm / 41.33 in
Width: 145 cm / 57.08 in
Depth: 85 cm / 33.46 in

WEIGHT

Weight: 44 kg
Packaging: 3 kg

MATERIALS

Oak, American and European walnut, elm, cherry, maple, ash

WOOD FINISHES

Available in a variety of natural oil and soap finishes. Discover more information artisan.ba/materials

UPHOLSTERY

Available in a variety of leathers and fabrics. More information at artisan.ba/materials

CLEANING INSTRUCTIONS

Please download our material care & cleaning instructions through artisan.ba/materials

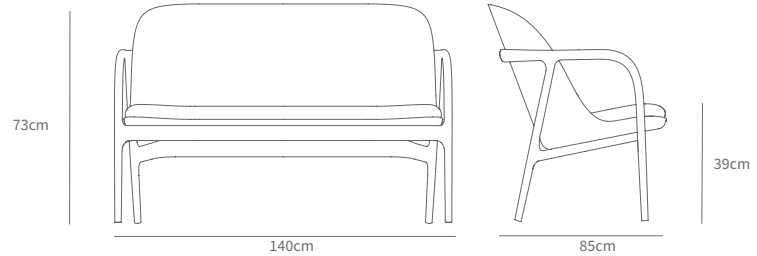

DESCRIPTION

The Neva lounge collection designed by Regular Company is a refined study in the natural elegance of wood. Defined by flowing lines and organic curves, each piece showcases the warmth, grain, and tactile richness of solid wood - inviting a deeper connection to material and form. The collection comprises a lounge chair, two-seater sofa, and ottoman, each available with a low or high backrest. Designed for comfort and visual balance, Neva pairs sculpted wood frames with upholstered seating to suit both residential and commercial environments. Explore its versatility further with a choice of seven solid wood types and upholstery options in premium leathers or fabrics.

PRODUCTION PROCESS

The wooden parts of the sofa are made of solid wood pieces of the same length but different widths, with precisely crafted joints produced on CNC machines. Each piece is chosen through careful matching of wood colors and structures. The upholstered seats are covered with HR foam and upholstery for superior comfort. The technical parameters of hand-assembled chairs comply with standard requirements. Final sanding is done manually with fine-grained sandpaper, and various types of finishes enable a wide selection of the chair's final appearance.

PRODUCT TYPE

Sofa

USAGE

Indoor

DISMANTLING OPTION

No

GLIDERS

Standard gliders

STOCK ITEMS

No

COUNTRY OF ORIGIN

BiH

NOTE

The listed weights are approximate; the weight of each piece depends on the type of wood.

DIMENSIONS

Height: 73 cm/ 28.74 in
Width: 140 cm/55.12 in
Depth: 85 cm/33.46 in
Seat height: 39 cm/ 15.35 in
Seat size: 133x56cm / 52.36x22.04 in

PACKAGING

Stretch wrap + five-layer cardboard box.
1 piece

PACKAGING DIMENSIONS

Height: 85 cm/ 33.46 in
Width: 145 cm/ 57.08 in
Depth: 85 cm/ 33.46 in

WEIGHT

Weight: 36 kg
Packaging: 3 kg

MATERIALS

Oak, American and European walnut, elm, cherry, maple, ash

WOOD FINISHES

Available in a variety of natural oil and soap finishes. Discover more information artisan.ba/materials

UPHOLSTERY

Available in a variety of leathers and fabrics. More information at artisan.ba/materials

CLEANING INSTRUCTIONS

Please download our material care & cleaning instructions through artisan.ba/materials

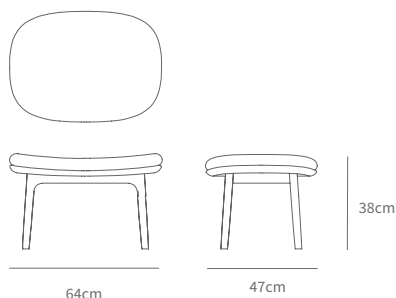

DESCRIPTION

The Neva lounge collection designed by Regular Company is a refined study in the natural elegance of wood. Defined by flowing lines and organic curves, each piece showcases the warmth, grain, and tactile richness of solid wood - inviting a deeper connection to material and form. The collection comprises a lounge chair, two-seater sofa, and ottoman, each available with a low or high backrest. Designed for comfort and visual balance, Neva pairs sculpted wood frames with upholstered seating to suit both residential and commercial environments. Explore its versatility further with a choice of seven solid wood types and upholstery options in premium leathers or fabrics.

PRODUCTION PROCESS

The wooden parts of the ottoman are made of solid wood pieces of the same length but different widths, with precisely crafted joints produced on CNC machines. Each piece is chosen through careful matching of wood colors and structures. The upholstered seats are covered with HR foam and upholstery for superior comfort. The technical parameters of hand-assembled chairs comply with standard requirements. Final sanding is done manually with fine-grained sandpaper, and various types of finishes enable a wide selection of the chair's final appearance.

PRODUCT TYPE

Ottoman

USAGE

Indoor

DISMANTLING OPTION

No

GLIDERS

Standard gliders

STOCK ITEMS

No

COUNTRY OF ORIGIN

BiH

NOTE

The listed weights are approximate; the weight of each piece depends on the type of wood.

DIMENSIONS

Height: 38 cm / 16.96 in

Width: 64 cm / 55.12 in

Depth: 47 cm / 33.46 in

Seat height: 40 cm / 15.35 in

Seat size: 64x47cm / 51.97x18.90 in

Leg diameter: \varnothing 2.7 - 3.3 cm / \varnothing 1.02 - 1.73 in

PACKAGING

Stretch wrap + five-layer cardboard box.

1 piece

PACKAGING DIMENSIONS

Height: 45 cm / 17.71 in

Width: 70 cm / 27.55 in

Depth: 50 cm / 19.68 in

WEIGHT

Weight: 16 kg

Packaging: 3 kg

MATERIALS

Oak, American and European walnut, elm, cherry, maple, ash

WOOD FINISHES

Available in a variety of natural oil and soap finishes. Discover more information artisan.ba/materials

UPHOLSTERY

Available in a variety of leathers and fabrics.

More information at artisan.ba/materials

CLEANING INSTRUCTIONS

Please download our material care & cleaning instructions through artisan.ba/materials

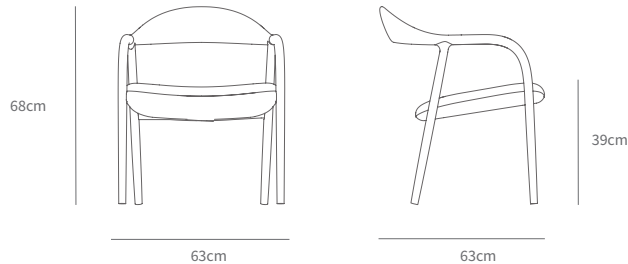

DESCRIPTION

Discover the Neva easy chair, a stunning creation that embodies a sensuous and fluid design language, skilfully expressed through the gentle interplay of soft, angular edges and seamless transitions. Its distinctive tilted and arched backrest seamlessly melds into the armrests, forming a continuous line that gracefully descends into the front legs. Each piece is meticulously hand-finished by seasoned craftsmen, ensuring impeccable quality. The Neva easy is available in a solid wood seat or comfortable upholstery, in an array of premium leathers or fabrics.

PRODUCTION PROCESS

The chair's frame is made from carefully selected wooden elements (lamellas) of the same length but varying widths, precisely crafted and joined with CNC technology for seamless connections. Each element is matched by color and grain to ensure visual harmony. Certain components are shaped using advanced wood-bending techniques, while final sanding is done by hand with fine-grained sandpaper to achieve a perfectly smooth surface. The chair is finished with various treatment options, allowing customization of the final appearance. Hand-assembled and built to meet technical standards, the Neva easy chair reflects the meticulous craftsmanship and timeless quality Artisan is known for.

PRODUCT TYPE

Lounge chair

USAGE

Indoor

DISMANTLING OPTION

No

GLIDERS

Standard gliders

STOCK ITEMS

No

COUNTRY OF ORIGIN

BiH

NOTE

The listed weights are approximate; the weight of each piece depends on the type of wood.

DIMENSIONS

Height: 68 cm/ 26.77 in
Width: 63 cm/ 24.8 in
Depth: 63 cm/ 24.8 in
Seat height: 39 cm/ 15.35 in
Seat size: 58x49cm / 22.83x19.29 in

PACKAGING

Stretch wrap + five-layer cardboard box.
1 piece

PACKAGING DIMENSIONS

Height: 75 cm/ 29.53 in
Width: 70 cm/ 27.55 in
Depth: 70 cm/ 27.55 in

WEIGHT

Weight: 10 kg
Packaging: 2 kg

MATERIALS

Oak, American and European walnut, elm, cherry, maple, ash

WOOD FINISHES

Available in a variety of natural oil and soap finishes. Discover more information artisan.ba/materials

UPHOLSTERY

Available in a variety of leathers and fabrics. More information at artisan.ba/materials

CLEANING INSTRUCTIONS

Please download our material care & cleaning instructions through artisan.ba/materials

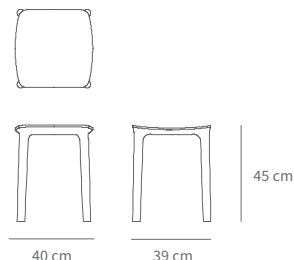

DESCRIPTION

The Neva stool is a study in simplicity and elegance, echoing the flowing lines and organic forms of the Neva collection. Its refined silhouette highlights the beauty of natural wood, with gentle curves that bring softness to its minimalistic shape. Designed to balance functionality and aesthetics, the Neva stool can serve as a versatile seating option, a side table, or an accent piece. Its understated design allows the material to take center stage, making it a timeless addition to any space.

PRODUCTION PROCESS

The stool frame is crafted from solid wood, with each element carefully cut and shaped for structural integrity and visual harmony. Wooden elements of the same length but varying widths are joined using CNC precision, ensuring flawless connections. The pieces are hand-matched for color and grain, and select components may be shaped using wood-bending techniques to achieve the stool's smooth contours. After assembly, the frame undergoes meticulous hand-sanding with fine-grained sandpaper, giving it a soft, velvety finish. The final step involves applying a protective finish, with a range of options available to customize the stool's appearance. The result is a perfectly balanced piece — durable, elegant, and crafted to stand the test of time.

PRODUCT TYPE

Stool

USAGE

Indoor

DISMANTLING OPTION

No

GLIDERS

Standard gliders

STOCK ITEMS

No

COUNTRY OF ORIGIN

BiH

NOTE

The listed weights are approximate; the weight of each piece depends on the type of wood.

DIMENSIONS

Height: 45 cm / 17.71 in

Width: 40 cm / 15.74 in

Depth: 39 cm / 15.35 in

Seat size: 38x38cm / in

Leg diameter: \varnothing 3.5-4 cm / \varnothing in

PACKAGING

Stretch wrap + five-layer cardboard box.

1 piece

PACKAGING DIMENSIONS

Height: 50 cm / 19.68 in

Width: 45 cm / 17.71 in

Depth: 45 cm / 17.71 in

WEIGHT

Weight: 6.5 kg

Packaging: 1.5 kg

MATERIALS

Oak, American and European walnut, elm, cherry, maple, ash

WOOD FINISHES

Available in a variety of natural oil and soap finishes. Discover more information artisan.ba/materials

UPHOLSTERY

Available in a variety of leathers and fabrics.

More information at artisan.ba/materials

CLEANING INSTRUCTIONS

Please download our material care & cleaning instructions through artisan.ba/materials

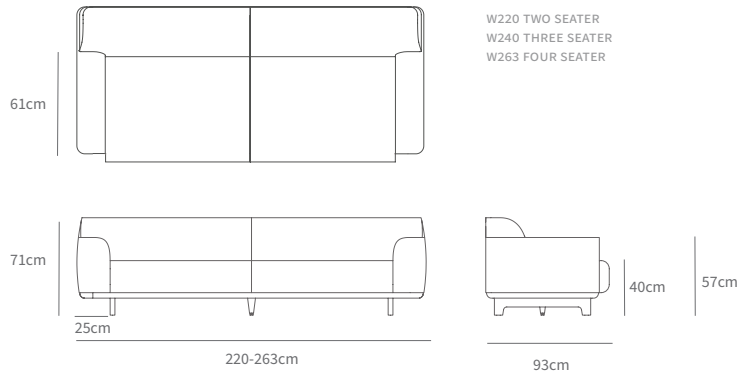

DESCRIPTION

The Tara sofa pairs classic proportions with exceptional comfort and craftsmanship. Its solid wood frame supports a generous upholstered seat, available in two, three, or four-seater configurations, with the option to extend into a sleeper. The warmth of wood meets a soft, refined form suited to both contemporary and timeless interiors. Explore its versatility further with a choice of seven solid wood types and upholstery options in leather or fabric, allowing you to curate the perfect seating solution for your space.

PRODUCTION PROCESS

Artisan specializes in the handcrafted creation of high-quality wooden furniture, with a strong emphasis on traditional craftsmanship. The wooden surfaces of the Tara sofa are treated with natural oils to enhance the organic beauty of the grain. The seat and back cushions are upholstered with premium fabrics or leather, providing both comfort and style. The upholstery is carefully chosen for its texture, durability, and aesthetic compatibility with the wooden frame. Attention is given to the precision of stitching and cushioning to ensure a soft yet supportive seating experience. The final result is a beautifully crafted piece, where the balance of wood and fabric creates a timeless design.

PRODUCT TYPE

Sofa

USAGE

Indoor

DISMANTLING OPTION

No

GLIDERS

Felt pads

STOCK ITEMS

No

COUNTRY OF ORIGIN

BiH

NOTE

The listed weights are approximate; the weight of each piece depends on its dimensions and the type of wood.

DIMENSIONS

Height: 71cm / 27.95 in
Width: 220-263 cm / 86.61-103.54 in
Depth: 93 cm / 36.61 in
Seat height: 40 cm / 15.75 in
Seat depth: 61 cm / 15.75 in
Seat size:
220(170x61cm),240(190x61),260(213x61)
/ 86.61(66.92x24.01), 94.48 (74.80x24.01),
102.36(83.85x24,01) in
Armrest: 25 cm / 9.84 in

PACKAGING

Stretch wrap + five-layer cardboard box.
1 piece

PACKAGING DIMENSIONS

Height: 76 cm / 29.92 in
Width: 225-335 cm / 88.58-131.89 in
Depth: 98 cm / 35.58 in

WEIGHT

Weight: 80-100 kg
Packaging: 3 kg

MATERIALS

Oak, American and European walnut, elm, cherry, maple, ash

WOOD FINISHES

Available in a variety of natural oil and soap finishes. Discover more information artisan.ba/materials

UPHOLSTERY

Available in a variety of leathers and fabrics. More information at artisan.ba/materials

CLEANING INSTRUCTIONS

Please download our material care & cleaning instructions through artisan.ba/materials

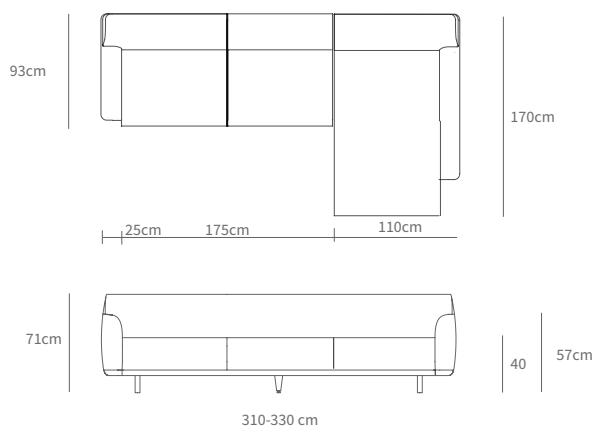

DESCRIPTION

The Tara sofa pairs classic proportions with exceptional comfort and craftsmanship. Its solid wood frame supports a generous upholstered seat, available in two, three, or four-seater configurations, with the option to extend into a sleeper. The warmth of wood meets a soft, refined form suited to both contemporary and timeless interiors. Explore its versatility further with a choice of seven solid wood types and upholstery options in leather or fabric, allowing you to curate the perfect seating solution for your space.

PRODUCTION PROCESS

Artisan specializes in the handcrafted creation of high-quality wooden furniture, with a strong emphasis on traditional craftsmanship. The wooden surfaces of the Tara Sofa are treated with natural oils to enhance the organic beauty of the grain. The seat and back cushions are upholstered with premium fabrics or leather, providing both comfort and style. The upholstery is carefully chosen for its texture, durability, and aesthetic compatibility with the wooden frame. Attention is given to the precision of stitching and cushioning to ensure a soft yet supportive seating experience. The final result is a beautifully crafted piece, where the balance of wood and fabric creates a timeless design.

PRODUCT TYPE

Sofa

USAGE

Indoor

DISMANTLING OPTION

Yes

GLIDERS

Felt pads

STOCK ITEMS

No

COUNTRY OF ORIGIN

BiH

NOTE

Chaise lounge can be left or right. The listed weights are approximate; the weight of each piece depends on its dimensions and the type of wood.

DIMENSIONS

Height: 71cm/ 27.95 in
Width: 310, 330 cm/ 122.04, 129.92 in
Depth: 93 cm/ 36.61 in
Seat height: 40 cm/ 15.75 in
Seat depth: 61 cm/ 15.75 in
Seat size: 330(195x61-138x85) / 129.92
(76.77x24.01-54.33x33.46) in
Armrest: 25 cm / 9.84 in

PACKAGING

Stretch wrap + five-layer cardboard box.
1 piece

PACKAGING DIMENSIONS

Height: 76 cm/ 29.92 in
Width: 225-335 cm/ 88.58-131.89 in
Depth: 98 cm/ 35.58 in

WEIGHT

Weight: 100-120 kg
Packaging: 3 kg

MATERIALS

Oak, American and European walnut, elm, cherry, maple, ash

WOOD FINISHES

Available in a variety of natural oil and soap finishes. Discover more information artisan.ba/materials

UPHOLSTERY

Available in a variety of leathers and fabrics. More information at artisan.ba/materials

CLEANING INSTRUCTIONS

Please download our material care & cleaning instructions through artisan.ba/materials

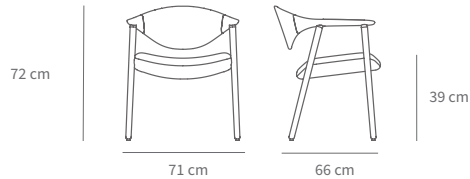

DESCRIPTION

Superb craftsmanship, the Naru lounge seamlessly blends sculptural elegance with tactile refinement. Defined by fluid curves and an organic form, this piece embodies the essence of contemporary artisanal design. Meticulously handcrafted from sustainably sourced wood, the Naru Lounge offers a bespoke touch, with the option to upholster the seat and back in leather or fabric. Perfectly suited for luxury residential interiors, boutique hospitality spaces, and high-end commercial projects, the Naru Lounge elevates any environment with its timeless presence.

PRODUCTION PROCESS

Each Naru lounge chair is carefully handcrafted by skilled artisans, blending precision engineering with traditional woodworking techniques. The frame is constructed from high-quality, sustainably sourced hardwoods, chosen for their strength and natural beauty. The wooden elements are cut and shaped using latest technology to ensure clean, precise connections. Metal reinforcements are discreetly added at key armrest joints to enhance stability and durability without compromising the design's elegance. For added comfort, the seat and backrest are upholstered with high-resilience foam and covered in premium fabric or leather. Once assembled, the chair undergoes manual sanding with fine-grained sandpaper to achieve a flawless finish. A final protective coating is applied, available in various finishes to highlight the wood's natural grain and ensure long-lasting durability. This thoughtful combination of craftsmanship and technical precision results in a lounge chair that is as inviting as it is timeless - a true reflection of Artisan's commitment to quality and design.

PRODUCT TYPE

Lounge chair

USAGE

Indoor

DISMANTLING OPTION

No

GLIDERS

Standard gliders

STOCK ITEMS

No

COUNTRY OF ORIGIN

BiH

NOTE

The listed weights are approximate; the weight of each piece depends on the type of wood.

DIMENSIONS

Height: 72 cm/ 28.35 in
Width: 71 cm/ 27.95 in
Depth: 66 cm/ 25.98 in
Seat height: 39 cm/ 15.35 in
Seat size: 55x53 cm/ 21.65x20.87 in

PACKAGING

Stretch wrap + five-layer cardboard box.
1 piece

PACKAGING DIMENSIONS

Height: 80 cm/ 31.5 in
Width: 70 cm/ 27.56 in
Depth: 80 cm/ 31.5 in

WEIGHT

Weight: 15 kg
Packaging: 3 kg

MATERIALS

Oak, American and European walnut, elm, cherry, maple, ash

WOOD FINISHES

Available in a variety of natural oil and soap finishes. Discover more information artisan.ba/materials

UPHOLSTERY

Available in a variety of leathers and fabrics. More information at artisan.ba/materials

DECORATION RINGS FINISHES

Inox, Brass, Powder - coated steel rings on request

CLEANING INSTRUCTIONS

Please download our material care & cleaning instructions through artisan.ba/materials

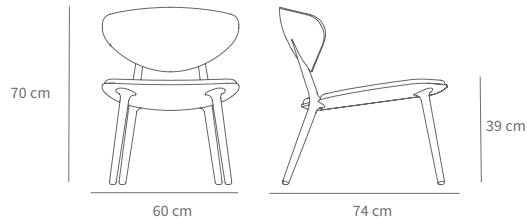

DESCRIPTION

The Wu lounge chair stands as a distinctive embodiment of character and style, seamlessly transitioning between residential and contract settings with ease. Choose from a palette of seven different wood types, including European oak, walnut, maple, elm, cherry, American Walnut and Ash, each enhanced by various natural finishes, such as oils and soap. For an added layer of personalisation, the Wu lounge chair offers options for a solid wood seat or upholstery, featuring a range of premium leathers or fabrics. Additionally, you can select for an optional backrest upholstery.

PRODUCTION PROCESS

The creation of the Wu lounge chair begins with a thoughtful design process, focusing on achieving a sleek, ergonomic silhouette. High-quality, sustainably sourced wood is carefully selected for its strength and aesthetic appeal. The frame is cut and shaped with precision tools to ensure seamless joints and structural stability, while the soft, flowing lines are refined through meticulous hand-sanding. The seat and backrest are upholstered with high-resilience foam and covered in premium fabric or leather, chosen for comfort and durability. The upholstery is expertly fitted, with detailed stitching that enhances both the chair's aesthetic and functional qualities. After assembly, the frame is treated with a natural oil or lacquer finish to protect the wood and bring out its grain. Each chair undergoes a final quality inspection to ensure it meets Artisan's high standards, resulting in a piece that is not only visually stunning but built to last - a timeless embodiment of craftsmanship and design.

PRODUCT TYPE

Lounge chair

USAGE

Indoor

DISMANTLING OPTION

No

GLIDERS

Standard gliders

STOCK ITEMS

No

COUNTRY OF ORIGIN

BiH

NOTE

Available with upholstered seat and backrest. The listed weights are approximate; the weight of each piece depends on the type of wood.

DIMENSIONS

Height: 70 cm / 27.59 in
Width: 60 cm / 23.62 in
Depth: 74 cm / 29.13 in
Seat height: 39 cm / 15.35 in
Seat size: 60x64cm / 25.2x18.5 in

PACKAGING

Stretch wrap + five-layer cardboard box.
1 piece

PACKAGING DIMENSIONS

Height: 85 cm / 33.46 in
Width: 75 cm / 29.52 in
Depth: 85 cm / 33.46 in

WEIGHT

Weight: 15 kg
Packaging: 2.5 kg

MATERIALS

Oak, American and European walnut, elm, cherry, maple, ash

WOOD FINISHES

Available in a variety of natural oil and soap finishes. Discover more information artisan.ba/materials

UPHOLSTERY

Available in a variety of leathers and fabrics. More information at artisan.ba/materials

CLEANING INSTRUCTIONS

Please download our material care & cleaning instructions through artisan.ba/materials

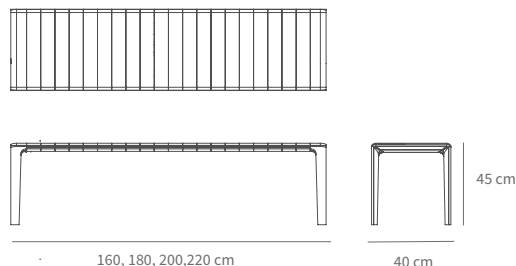

DESCRIPTION

The Invito bench embodies a bold, timeless beauty, defined by strong, sculptural forms and the natural power of solid wood. The design celebrates simplicity, where carefully balanced proportions and clean lines evoke a sense of reliability, durability, and comfort. Each element is crafted to showcase the raw elegance of wood, with expressive shapes and thoughtful contrasts in texture, tone, and color that add depth and character to the piece. The sturdy legs and supportive structure emphasise stability, while subtle design details enrich the bench's understated yet powerful presence. Invito is a collection that quietly commands attention - a testament to the strength of honest materials and masterful craftsmanship.

PRODUCTION PROCESS

The Invito bench is crafted with precision and care, starting with the selection of high-quality, sustainably sourced hardwoods. Each wooden element is meticulously chosen to ensure consistency in grain, tone, and structure. The components are cut and shaped using CNC technology for accuracy, followed by hand-finishing to refine every curve and edge. The bench's robust frame is assembled with precision joinery techniques, reinforcing the design's inherent strength and longevity. Artisans carefully sand the surfaces with fine-grained sandpaper, ensuring a smooth, flawless finish. Natural oils or matte lacquers are applied to protect the wood and enhance its organic beauty, allowing the grain and natural variations to shine through. The result is a piece that feels both grounded and refined - a bench designed to endure, aging gracefully as it tells the story of its material and the skill of its makers.

PRODUCT TYPE

Bench

USAGE

Indoor

DISMANTLING OPTION

No

GLIDERS

Standard gliders

STOCK ITEMS

No

COUNTRY OF ORIGIN

BiH

NOTE

Other modifications and prices on request.
The listed weights are approximate; the weight of each piece depends on its dimensions and the type of wood.

DIMENSIONS

Height: 45 cm/ 17.72 in
Width: 160 - 220 cm/ 62.99 - 86.61 in
Depth: 40 cm/ 15.74 in
Top thickness: 2 cm/ 0.39 in
Visually: 7.5 cm/ 2.95 in

PACKAGING

Stretch wrap + five layer cardboard box
1 piece

PACKAGING DIMENSIONS

Height: 50 cm/ 31.5 in
Width: 165-225 cm/ 64.96- 88.58 in
Depth: 45 cm/ 31.5 in

WEIGHT

Weight: 25-40 kg
Packaging: 3 kg

WOOD

Oak, American and European walnut, elm, cherry, maple, ash

WOOD FINISHES

Available in a variety of natural oil and soap finishes.
More information at artisan.ba/materials

UPHOLSTERY

Available in a variety of leathers and fabrics.
More information at artisan.ba/materials

CLEANING INSTRUCTIONS

Please download our material care & cleaning instructions through artisan.ba/materials



DESCRIPTION

Tranquil lines of extremely fine craftsmanship highlight the beauty of the material and evoke a continuous flow by masterfully soft transitions, creating a functional yet sculptural quality. The beauty of design is accentuated by the understanding of the raw material, by respecting and visually underlining the structure of wood, creating a unique quality of aesthetics and an elegant structure.

PRODUCTION PROCESS

The Latus bench is brought to life through a meticulous blend of modern precision and traditional craftsmanship. The process begins with the careful selection of high-quality, sustainably sourced hardwoods, chosen for their strength, durability, and natural beauty. Each wooden element is cut and shaped with precision CNC technology to achieve clean lines and smooth curves that define the bench's elegant silhouette. The frame is assembled using advanced joinery techniques to ensure structural integrity, while the surfaces are hand-sanded to perfection. The final shaping is done by artisans, who refine every edge and contour to enhance the bench's tactile appeal. The wood is then treated with natural oils or finishes that protect the surface while highlighting the intricate grain patterns, adding warmth and depth to the piece. For added comfort, the bench can be optionally upholstered, with high-resilience foam and carefully fitted fabric or leather, tailored to complement the wood's natural elegance. After a final quality inspection, the finished bench embodies both strength and sophistication - a timeless piece built to last for generations.

PRODUCT TYPE

Bench

USAGE

Indoor

DISMANTLING OPTION

No

GLIDERS

Standard Gliders

STOCK ITEMS

No

COUNTRY OF ORIGIN

BiH

NOTE

Other modifications and prices on request.
The listed weights are approximate; the weight of each piece depends on its dimensions and the type of wood.

DIMENSIONS

Height: 45 cm/ 17.72 in
Width: 160 - 220 cm/ 62.99 - 86.61 in
Depth: 40 cm/ 15.75 in
Top thickness: 4 cm/ 1.57 in
Visually: 6 cm/ 2.36 in

PACKAGING

Stretch wrap + five layer cardboard box
1 piece

PACKAGING DIMENSIONS

Height: 50 cm/ 19.68 in
Width: 165-225 cm/ 64.96- 88.58 in
Depth: 45 cm/ 17.71 in

WEIGHT

Weight: 26-36 kg
Packaging: 3 kg

WOOD

Oak, American and European walnut, elm, cherry, maple, ash

WOOD FINISHES

Available in a variety of natural oil and soap finishes. Discover more information artisan.ba/materials

UPHOLSTERY

Available in a variety of leathers and fabrics.
More information at artisan.ba/materials

CLEANING INSTRUCTIONS

Please download our material care & cleaning instructions through artisan.ba/materials

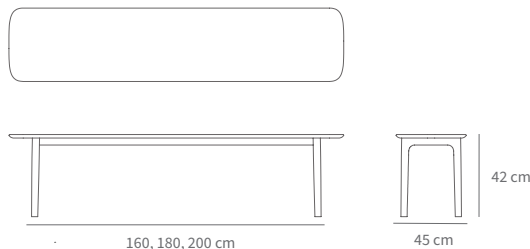

DESCRIPTION

An ongoing flow of soft lines defines elegant units; it respects ergonomics and sophisticatedly rounds off an understated yet identifiable aesthetics. Like typeface, certain elements reappear in variations of clearly defined hallmark traits, characteristic strokes whose soft wood lines trace out the desired form, adapting themselves to the use by altering the line flow. Seating furniture variations are completed with practical cabinets, all subtly connected by a common aesthetic with a chance of creating a pleasant ambience out of similar elements. Thanks to their unobtrusive beauty, the elements from the Neva collection gracefully fit in already established interiors and adapt themselves to them, refining them while never losing their distinction.

PRODUCTION PROCESS

The Neva bench is handcrafted with soft, flowing lines that balance solid wood and upholstery. High-quality, sustainably sourced hardwood is precisely cut with CNC technology and hand-finished to smooth every curve and highlight the wood's natural beauty. The bench is assembled with advanced joinery for lasting stability. The seat is upholstered with high-resilience foam and covered in premium fabric or leather, carefully fitted with precise stitching for comfort and elegance. Finally, the wood is hand-sanded and treated with a protective finish, resulting in a timeless piece where natural materials and thoughtful craftsmanship come together seamlessly.

PRODUCT TYPE

Bench

USAGE

Indoor

DISMANTLING OPTION

No

GLIDERS

Standard gliders

STOCK ITEMS

No

COUNTRY OF ORIGIN

BiH

NOTE

Other modifications and prices on request.
The listed weights are approximate; the weight of each piece depends on its dimensions and the type of wood.

DIMENSIONS

Height: 42 cm/ 16.53 in
Width: 160,180, 200 cm/ 62.99,70.86,78.74 in
Depth: 45 cm/ 17.72 in
Top thickness: 4 cm/ 1.57 in
Visually: 4 cm/ 1.57 in

PACKAGING

Stretch wrap + five layer cardboard box
1 piece

PACKAGING DIMENSIONS

Height: 50 cm/ 19.68 in
Width: 165 - 225 cm/ 64.96 - 88.58 in
Depth: 45 cm/ 17.71 in

WEIGHT

Weight: 20-30 kg
Packaging: 2-3 kg

WOOD

Oak, American and European walnut, elm, cherry, maple, ash

WOOD FINISHES

Available in a variety of natural oil and soap finishes. Discover more information artisan.ba/materials

UPHOLSTERY

Available in a variety of leathers and fabrics.
More information at artisan.ba/materials

CLEANING INSTRUCTIONS

Please download our material care & cleaning instructions through artisan.ba/materials

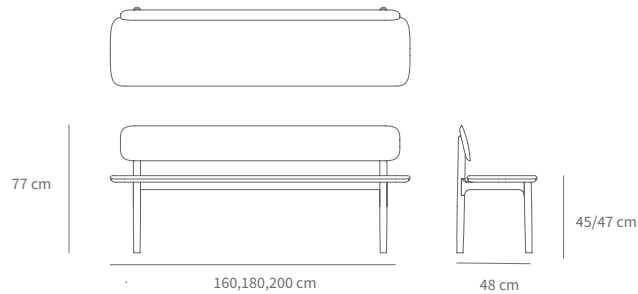

DESCRIPTION

An ongoing flow of soft lines defines elegant units; it respects ergonomics and sophisticatedly rounds off an understated yet identifiable aesthetics. Like typeface, certain elements reappear in variations of clearly defined hallmark traits, characteristic strokes whose soft wood lines trace out the desired form, adapting themselves to the use by altering the line flow. Seating furniture variations are completed with practical cabinets, all subtly connected by a common aesthetic with a chance of creating a pleasant ambience out of similar elements. Thanks to their unobtrusive beauty, the elements from the Neva collection gracefully fit in already established interiors and adapt themselves to them, refining them while never losing their distinction.

PRODUCTION PROCESS

The Neva bench is handcrafted with soft, flowing lines that balance solid wood and upholstery. High-quality, sustainably sourced hardwood is precisely cut with CNC technology and hand-finished to smooth every curve and highlight the wood's natural beauty. The bench is assembled with advanced joinery for lasting stability, featuring a gracefully curved wooden backrest that adds both support and sculptural elegance. The seat is upholstered with high-resilience foam and covered in premium fabric or leather, carefully fitted with precise stitching for comfort and refinement. Finally, the entire piece is hand-sanded and treated with a protective finish, resulting in a timeless bench where natural materials and thoughtful craftsmanship come together seamlessly.

PRODUCT TYPE

Bench

USAGE

Indoor

DISMANTLING OPTION

No

GLIDERS

Standard gliders

STOCK ITEMS

No

COUNTRY OF ORIGIN

BiH

NOTE

Other modifications and prices on request.
The listed weights are approximate; the weight of each piece depends on its dimensions and the type of wood.

DIMENSIONS

Seat height: - 45 wooden seat/ 17.72 in
- 47 upholstered seat/ 18.5 in
Backrest height: 77 cm/ 30.31 in
Width: 160,180,200 cm/ 62.99, 70.86, 78.74 in
Depth: 48 cm/ 18.89 in
Top thickness: 4 cm/ 1.57 in
Visually: 4 cm/ 1.57 in

PACKAGING

Stretch wrap + five layer cardboard box
1 piece

PACKAGING DIMENSIONS

Height: 80 cm/ 31.49 in
Width: 165-225 cm/ 64.96- 88.58 in
Depth: 55 cm/ 21.65 in

WEIGHT

Weight: 20-35 kg
Packaging: 3 kg

WOOD

Oak, American and European walnut, elm, cherry, maple, ash

WOOD FINISHES

Available in a variety of natural oil and soap finishes. Discover more information artisan.ba/materials

UPHOLSTERY

Available in a variety of leathers and fabrics.
More information at artisan.ba/materials

CLEANING INSTRUCTIONS

Please download our material care & cleaning instructions through artisan.ba/materials



DESCRIPTION

The Thor bench showcases the timeless beauty of solid wood through bold, architectural forms and clean lines. Robust yet refined, Thor balances strength and simplicity, offering a versatile seating solution that enhances any space with its natural elegance. Every surface is carefully crafted to highlight the rich character of the wood, while the precise connections and subtle details reflect Artisan's dedication to masterful craftsmanship. Whether used as a standalone piece or paired with other elements, the Thor bench brings a grounded, sculptural presence to interiors.

PRODUCTION PROCESS

The Thor bench is carefully handcrafted to balance strength and elegance. High-quality, sustainably sourced hardwood is precisely cut with CNC technology, then hand-finished to smooth every surface and highlight the natural grain. The frame is assembled with traditional joinery, ensuring lasting stability. The seat is upholstered with high-resilience foam and covered in premium fabric or leather, expertly tailored for comfort and a refined finish. Finally, the wood is treated with a protective coating, enhancing its durability and timeless appeal. The result is a beautifully crafted bench where natural materials and skilled craftsmanship come together seamlessly.

PRODUCT TYPE

Bench

USAGE

Indoor

DISMANTLING OPTION

No

GLIDERS

Standard gliders

STOCK ITEMS

No

COUNTRY OF ORIGIN

BiH

DIMENSIONS

Height: 43 cm/ 16.92 in

Width: 120,150,180 cm/ 47.24,59.05,70.86 in

Depth: 45 cm/ 17.71 in

PACKAGING

Stretch wrap + five layer cardboard box

1 piece

PACKAGING DIMENSIONS

Height: 45 cm/ 17.71 in

Width: 125 - 150 cm/ 49.21 -59.05 in

Depth: 55 cm/ 21.65 in

WEIGHT

Weight: 21-25 kg

Packaging: 2 kg

WOOD

Oak, American and European walnut, elm, cherry, maple, ash

WOOD FINISHES

Available in a variety of natural oil and soap finishes.

More information at artisan.ba/materials

UPHOLSTERY

Available in a variety of leathers and fabrics.

More information at artisan.ba/materials

CLEANING INSTRUCTIONS

Please download our material care & cleaning instructions through artisan.ba/materials

NOTE

Other modifications and prices on request.

Mega lengths and between sizes possible.

The listed weights are approximate; the weight of each piece depends on its dimensions and the type of wood.

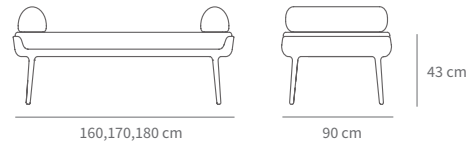

DESCRIPTION

The Thor daybed extends the collection's philosophy of strength, comfort, and minimalist sophistication. Combining solid wood craftsmanship with a thoughtfully upholstered surface, Thor offers a generous space for rest, reflection, or casual seating. Two cushions, designed specifically for the daybed, enhance comfort and add subtle elegance to the overall composition. Its pure, structural design emphasizes honest materials and flawless detailing, while the soft, inviting mattress and cushions contrast beautifully with the bold wooden frame. Designed with balance and proportion in mind, the Thor daybed embodies Artisan's philosophy of creating timeless pieces where functionality meets enduring beauty.

PRODUCTION PROCESS

The Thor daybed is carefully handcrafted to balance strength and elegance. High-quality, sustainably sourced hardwood is precisely cut with CNC technology, then hand-finished to smooth every surface and highlight the natural grain. The frame is assembled with traditional joinery, ensuring lasting stability. The seat is upholstered with high-resilience foam and covered in premium fabric or leather, expertly tailored for comfort and a refined finish. Finally, the wood is treated with a protective coating, enhancing its durability and timeless appeal. The result is a beautifully crafted bench where natural materials and skilled craftsmanship come together seamlessly.

PRODUCT TYPE

Daybed

USAGE

Indoor

DISMANTLING OPTION

No

GLIDERS

Standard gliders

STOCK ITEMS

No

COUNTRY OF ORIGIN

BiH

DIMENSIONS

Height: 43 cm / 19.92 in
Width: 160,170,180 cm / 62.99,66.92,70.86 in
Depth: 90 cm / 35.43 in

PACKAGING

Stretch wrap + five layer cardboard box
1 piece

PACKAGING DIMENSIONS

Height: 45 cm / 17.71 in
Width: 185 cm / 72.83 in
Depth: 55 cm / 21.65 in

WEIGHT

Weight: 38-51 kg
Packaging: 2-3 kg

WOOD

Oak, American and European walnut, elm, cherry, maple, ash

WOOD FINISHES

Available in a variety of natural oil and soap finishes. Discover more information artisan.ba/materials

UPHOLSTERY

Available in a variety of leathers and fabrics. More information at artisan.ba/materials

CLEANING INSTRUCTIONS

Please download our material care & cleaning instructions through artisan.ba/materials

NOTE

Dimensions of the cushions:
H23 x W63 x D15.4cm.
Other modifications and prices on request.
Mega lengths and between sizes possible.
The listed weights are approximate; the weight of each piece depends on its dimensions and the type of wood.

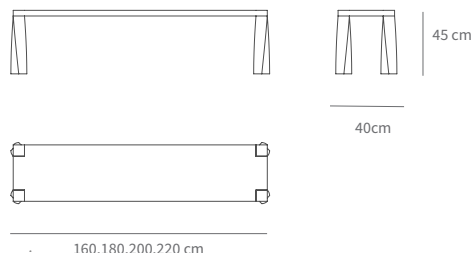

DESCRIPTION

The Tor bench embodies simplicity and strength, showcasing the timeless beauty of solid wood through clean lines and harmonious proportions. Designed to highlight the wood's natural character, the bench's minimalist silhouette feels both grounded and elegant, seamlessly fitting into various interiors. The gentle curves of the seat enhance comfort, while the sturdy frame exudes durability. Every detail, from the subtle grain variations to the smooth finish, reflects a deep respect for nature and craftsmanship. The Tor bench is not just a piece of furniture - it's an understated sculpture, inviting touch and admiration through its honest design and thoughtful execution.

PRODUCTION PROCESS

The Tor bench is meticulously crafted from sustainably sourced hardwoods, chosen for their strength and distinctive grain patterns. The production process starts with precision CNC cutting to shape each component, followed by expert hand-finishing to refine the wood's curves and surfaces. Traditional joinery techniques ensure structural integrity, while final hand-sanding and the application of natural oil or wax finishes protect the wood and accentuate its natural warmth. The result is a timeless, functional piece where nature's raw beauty meets Artisan's signature craftsmanship.

PRODUCT TYPE

Bench

USAGE

Indoor

DISMANTLING OPTION

No

GLIDERS

Felt pads

STOCK ITEMS

No

COUNTRY OF ORIGIN

BiH

NOTE

Other modifications and prices on request.
Mega lengths and between sizes possible.
The listed weights are approximate; the weight of each piece depends on its dimensions and the type of wood.

DIMENSIONS

Height: 45 cm / 17.72 in
Width: 160,180,200 220 cm / 62.99,70.86,
78.7486.61 in
Depth: 40 cm / 15.75 in

PACKAGING

Stretch wrap + five layer cardboard box
1 piece

PACKAGING DIMENSIONS

Height: 50 cm / 19.68 in
Width: 165-225 cm / 64.96- 88.58 in
Depth: 45 cm / 17.71 in

WEIGHT

Weight: 23-38 kg
Packaging: 2-3 kg

WOOD

Oak, American and European walnut, elm,
cherry, maple, ash

WOOD FINISHES

Available in a variety of natural oil and soap
finishes. Discover more information [artisan.ba/
materials](https://artisan.ba/materials)

CLEANING INSTRUCTIONS

Please download our material care & cleaning
instructions through artisan.ba/materials

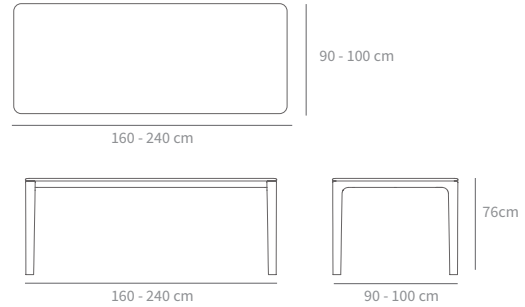

H 76 W 160, 180, 200, 220, 240 D 90, 100 CM

DESCRIPTION

An ongoing flow of soft lines defines elegant units; it respects ergonomics and sophisticatedly rounds off an understated yet identifiable aesthetics. Like typeface, certain elements reappear in variations of clearly defined hallmark traits, characteristic strokes whose soft wood lines trace out the desired form, adapting themselves to the use by altering the line flow. Thanks to their unobtrusive beauty, the elements from the Neva collection gracefully fit in already established interiors and adapt themselves to them, refining them while never losing their distinction. respecting ergonomics and completing a subtle yet identifiable aesthetic.

PRODUCTION PROCESS

Tables are crafted from carefully selected, high-quality solid wood, chosen for its durability and distinctive natural grain. Each piece of wood is precisely cut and shaped to achieve clean lines and balanced proportions. Skilled artisans meticulously assemble the components using traditional joinery techniques, ensuring lasting strength and stability. Surfaces are finely sanded to enhance the wood's texture and prepare it for finishing. The final stage involves applying a chosen finish - whether natural oil, wax, or another treatment - to protect the wood and highlight its organic beauty. The result is a versatile, handcrafted table that seamlessly blends functionality with timeless design.

PRODUCT TYPE

Table

USAGE

Indoor

DISMANTLING OPTION

Yes

GLIDERS

Felt pads

STOCK ITEMS

No

COUNTRY OF ORIGIN

BiH

NOTE

Mega lengths and between sizes possible. For lengths over 300 cm, a detachable **fifth leg** is required. Other modifications and prices on request.

The listed weights are approximate; the weight of each piece depends on its dimensions and the type of wood.

DIMENSIONS

Height: 76 cm/ 29.92 in
Width: 160-240 cm/ 62.99-94.49 in
Depth: 90-100/ 35.43-39.37 in
Top thickness: 2 cm/ 0.79 in
Visually: 7.5 cm/ 2.95 in
Leg dimensions: bottom 6x6 cm/ 2.36 in
top 7.5x7.5 cm/ 2.95 in

PACKAGING

Stretch wrap + five-layer cardboard box.
1 piece

PACKAGING DIMENSIONS

Height: 80 cm/ 31.49 in
Width: 165 cm/ 64.96 in
Depth: 95 cm/ 37.40 in

WEIGHT

Weight: 49 - 63 kg
Packaging: 3-5 kg

MATERIALS

Oak, American and European walnut, elm, cherry, maple, ash

TABLE TOP

Solid wood

TABLE BASE

Solid wood

WOOD FINISHES

Available in a variety of natural oil and soap finishes. Discover more information artisan.ba/materials

TABLE TOP AND BASE FINISHES

Available in a variety of natural oil and soap finishes. Discover more information artisan.ba/materials

CLEANING INSTRUCTIONS

Please download our material care & cleaning instructions through artisan.ba/materials

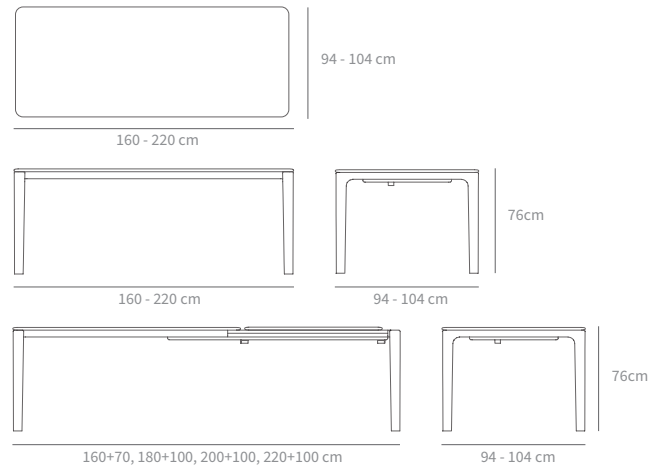

DESCRIPTION

An ongoing flow of soft lines defines elegant units; it respects ergonomics and sophisticatedly rounds off an understated yet identifiable aesthetics. Like typeface, certain elements reappear in variations of clearly defined hallmark traits, characteristic strokes whose soft wood lines trace out the desired form, adapting themselves to the use by altering the line flow. Thanks to their unobtrusive beauty, the elements from the Neva collection gracefully fit in already established interiors and adapt themselves to them, refining them while never losing their distinction. respecting ergonomics and completing a subtle yet identifiable aesthetic.

PRODUCTION PROCESS

Tables are crafted from carefully selected, high-quality solid wood, chosen for its durability and distinctive natural grain. Each piece of wood is precisely cut and shaped to achieve clean lines and balanced proportions. Skilled artisans meticulously assemble the components using traditional joinery techniques, ensuring lasting strength and stability. Surfaces are finely sanded to enhance the wood's texture and prepare it for finishing. The final stage involves applying a chosen finish - whether natural oil, wax, or another treatment - to protect the wood and highlight its organic beauty. The result is a versatile, handcrafted table that seamlessly blends functionality with timeless design.

PRODUCT TYPE

Extension table

USAGE

Indoor

DISMANTLING OPTION

Yes

GLIDERS

Felt pads + wheels on the movable part

STOCK ITEMS

No

COUNTRY OF ORIGIN

BiH

NOTE

Tolerance for hanging of the table:
Lengths of 160, 180, 200 cm, hanging max: 1,5 cm/ 0.59 in. Lengths of 200, 220 cm, hanging max: 2 cm/ 0.79 in.
The listed weights are approximate; the weight of each piece depends on its dimensions and the type of wood.

DIMENSIONS

Height: 76 cm/ 29.92 in
Width: 160+70, 180+100, 200+100, 220+100 cm/ 62.99+27.56, 70.87+39.37, 78.74+39.37, 86.61+39.37 in
Depth: 94-104 cm/ 37-40,94 in
Top thickness: 2 cm/ 0.79 in
Visually: 2 cm/ 0.79 in
Leg dimensions: bottom 6x6 cm/ 2.36 in
top 7.5x7.5 cm/ 2.95 in

PACKAGING

Stretch wrap + five-layer cardboard box.
1 piece

PACKAGING DIMENSIONS

Height: 80 cm/31.49 in
Width: 165-225 cm/64.96-88.5 in
Depth: 100-110 cm/39.37-43.30 in

WEIGHT

Weight: 67- 102 kg
Packaging: 6 - 7.5 kg

MATERIALS

Oak, American and European walnut, elm, cherry, maple, ash

TABLE TOP

Solid wood

TABLE BASE

Solid wood

WOOD FINISHES

Available in a variety of natural oil and soap finishes. Discover more information artisan.ba/materials

TABLE TOP AND BASE FINISHES

Available in a variety of natural oil and soap finishes. Discover more information artisan.ba/materials

CLEANING INSTRUCTIONS

Please download our material care & cleaning instructions through artisan.ba/materials

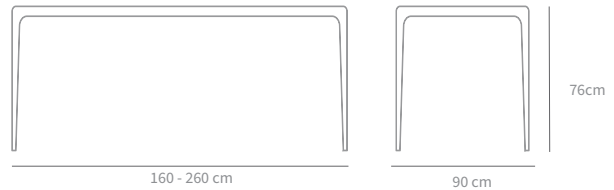

H 76 W 160, 180, 200, 220, 240, 260 D 70, 90 CM

DESCRIPTION

Fine gradation is the essence of the features in this table structure, which seems to be made from a single fine pencil stroke combined with exceptional wood processing craftsmanship. The table surface is accentuated thanks to wood structure lines. Softly processed edges make texture lines descend like waterfalls, rounding the edges or continuing their way down, transitioning into the load-bearing elements, the table's legs. Set at an angle, they underline the continuity of the flow and overall elegance. The surface thus transitions into lines getting thinner and thinner to the point of union with the floor. The steady and elegant structure results from a skilled harmonisation of aesthetic values of the raw material and a deliberate design, creating the impression of flying and enhancing space.

PRODUCTION PROCESS

Tables are crafted from carefully selected, high-quality solid wood, chosen for its durability and distinctive natural grain. Each piece of wood is precisely cut and shaped to achieve clean lines and balanced proportions. Skilled artisans meticulously assemble the components using traditional joinery techniques, ensuring lasting strength and stability. Surfaces are finely sanded to enhance the wood's texture and prepare it for finishing. The final stage involves applying a chosen finish - whether natural oil, wax, or another treatment - to protect the wood and highlight its organic beauty. The result is a versatile, handcrafted table that seamlessly blends functionality with timeless design.

PRODUCT TYPE

Table

USAGE

Indoor

DISMANTLING OPTION

Yes (only on request)

GLIDERS

Felt pads

STOCK ITEMS

No

COUNTRY OF ORIGIN

BiH

NOTE

Other modifications and prices on request.
For lengths over 270 cm, a detachable **fifth leg** is required. Between sizes possible: e. g. 205x85x76 cm
The listed weights are approximate; the weight of each piece depends on its dimensions and the type of wood.

DIMENSIONS

Height: 76cm / 29.92 in; 35 cm / 13.78 in
Width: 160 - 260 cm/ 62.99 - 102.36 in
Depth: 90 cm/ 27.56 - 35.43 in
Leg diameter: $\varnothing 3$ - $\varnothing 6$ cm/ $\varnothing 1.18$ - $\varnothing 2.36$ in
Top thickness: 4 cm/ 1.57 in
Visually: 6 cm/ 2.36 in

PACKAGING

Stretch wrap + five-layer cardboard box.
1 piece

PACKAGING DIMENSIONS

Height: 81 cm/ 31.89 in
Width: 165 - 265 cm/ 64.96 - 104.33 in
Depth: 75 - 95 cm/ 29.53 - 37.40 in

WEIGHT

Weight: 39 - 91 kg
Packaging: 2 - 3 kg

WOOD

Oak, American and European walnut, elm, cherry, maple, ash

TABLE TOP

Solid wood

TABLE BASE

Solid wood

WOOD FINISHES

Available in a variety of natural oil and soap finishes.
More information at artisan.ba/materials

TABLE TOP AND BASE FINISHES

Available in a variety of natural oil and soap finishes.
More information at artisan.ba/materials

CLEANING INSTRUCTIONS

Please download our material care & cleaning instructions through artisan.ba/materials

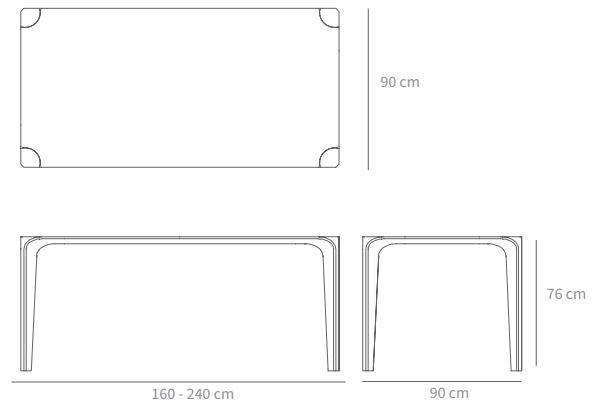

H 76 W 160, 180, 200, 220, 240 D 90 CM

DESCRIPTION

Forms flow into one another, occasionally create sharper edges underlining the beauty of forms, only to become soft and curved again, leading the gaze, calling for a tactile experience. The fine craftsmanship of processing the solid material, solid wood, creates extremely soft and fluid lines. The high level of final refinement evokes an impression of a curved form, of an ongoing flow of unique material surface. The material's structure generates a texture underlying the flow. An optical illusion of sorts ensues, visually alluring, without disturbing the function, accentuating the strength and pliability of the raw material by masterfully processing a delicate idea. The beauty of strong geometry has been softened by visible structure of the material, wood, adaptable in terms of colour and final processing, as well as in dimensions.

PRODUCTION PROCESS

Tables are crafted from carefully selected, high-quality solid wood, chosen for its durability and distinctive natural grain. Each piece of wood is precisely cut and shaped to achieve clean lines and balanced proportions. Skilled artisans meticulously assemble the components using traditional joinery techniques, ensuring lasting strength and stability. Surfaces are finely sanded to enhance the wood's texture and prepare it for finishing. The final stage involves applying a chosen finish - whether natural oil, wax, or another treatment - to protect the wood and highlight its organic beauty. The result is a versatile, handcrafted table that seamlessly blends functionality with timeless design.

PRODUCT TYPE

Table

USAGE

Indoor

DISMANTLING OPTION

No

GLIDERS

Felt pads

STOCK ITEMS

No

COUNTRY OF ORIGIN

BiH

NOTE

Mega lengths and between sizes possible. For lengths over 270 cm, a detachable **fifth leg** is required. Other modifications and prices on request.

The listed weights are approximate; the weight of each piece depends on its dimensions and the type of wood.

DIMENSIONS

Height: 76 cm / 29.92 in

Width: 160 - 240 cm / 62.99 - 94.49 in

Depth: 90 cm / 35.43 in

Top thickness: 4 cm / 1.57 in

Leg dimensions: bottom 6x4.2 cm / 2.36x1.65 in
top 9.5x4.2 cm / 3.74x1.65 in

PACKAGING

Stretch wrap + five-layer cardboard box.

1 piece

PACKAGING DIMENSIONS

Height: 81 cm, 40 cm / 31.89 in, 15.75 in

Width: 165 - 265 cm / 64.96 - 104.33 in

Depth: 75 - 95 cm / 29.53 - 37.40 in

WEIGHT

Weight: 49-63 kg

Packaging: 4-6 kg

WOOD

Oak, American and European walnut, elm, cherry, maple, ash

TABLE TOP

Solid wood

TABLE BASE

Solid wood

WOOD FINISHES

Available in a variety of natural oil and soap finishes.

More information at artisan.ba/materials

TABLE TOP AND BASE FINISHES

Available in a variety of natural oil and soap finishes.

More information at artisan.ba/materials

CLEANING INSTRUCTIONS

Please download our material care & cleaning instructions through artisan.ba/materials

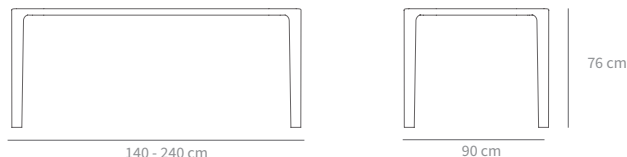

H 76 W 140, 160, 180, 200, 220, 240 D 90 CM

DESCRIPTION

The Mela table continues the philosophy of perfectly curved lines and refined aesthetics. Its sophisticated design is defined by clean, rounded forms that bring a sense of harmony and elegance to any space. The sturdy yet visually light solid wood structure naturally extends the Mela collection's signature style, offering both stability and warmth. Gently rounded edges and carefully crafted joints highlight the Artisan's craftsmanship and attention to detail. Seamlessly blending functionality and beauty, the Mela table creates an inviting setting for gathering, working, or relaxing.

PRODUCTION PROCESS

Tables are crafted from carefully selected, high-quality solid wood, chosen for its durability and distinctive natural grain. Each piece of wood is precisely cut and shaped to achieve clean lines and balanced proportions. Skilled artisans meticulously assemble the components using traditional joinery techniques, ensuring lasting strength and stability. Surfaces are finely sanded to enhance the wood's texture and prepare it for finishing. The final stage involves applying a chosen finish - whether natural oil, wax, or another treatment - to protect the wood and highlight its organic beauty. The result is a versatile, handcrafted table that seamlessly blends functionality with timeless design.

PRODUCT TYPE

Table

USAGE

Indoor

DISMANTLING OPTION

No

GLIDERS

Felt pads

STOCK ITEMS

No

COUNTRY OF ORIGIN

BiH

NOTE

Mega lengths and between sizes possible. For lengths over 270 cm, a detachable **fifth leg** is required. Other modifications and prices on request.

The listed weights are approximate; the weight of each piece depends on its dimensions and the type of wood.

DIMENSIONS

Height: 76 cm / 29.92 in
Width: 140 - 240 cm / 55.12 - 94.49 in
Depth: 90 cm / 35.43 in
Top thickness: 4 cm / 1.57 in
Visually: 4 cm / 1.57 in
Leg dimensions: bottom 6x6 cm / 2.36 in
top 7.5x7.5 cm / 2.95 in

PACKAGING

Stretch wrap + five-layer cardboard box.
1 piece

PACKAGING DIMENSIONS

Height: 81 cm, 40 cm / 31.89 in, 15.75 in
Width: 145 - 265 cm / 57.08 - 104.33 in
Depth: 75 - 95 cm / 29.53 - 37.40 in

WEIGHT

Weight: 46-63 kg
Packaging: 2-5 kg

WOOD

Oak, American and European walnut, elm, cherry, maple, ash

TABLE TOP

Solid wood

TABLE BASE

Solid wood

WOOD FINISHES

Available in a variety of natural oil and soap finishes.

More information at artisan.ba/materials

TABLE TOP AND BASE FINISHES

Available in a variety of natural oil and soap finishes.

More information at artisan.ba/materials

CLEANING INSTRUCTIONS

Please download our material care & cleaning instructions through artisan.ba/materials

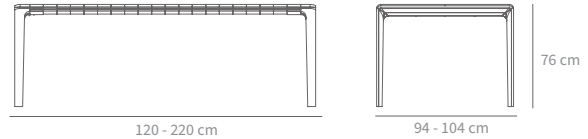

H 76 W 120, 140, 160, 180, 200, 220 D 94, 104 CM

DESCRIPTION

The Invito collection is defined by robust beauty, insisting on strong forms, effected with solid and compact basic material – wood. Simple, powerful, finely proportioned forms seem reliable, evoke durability, resistance and comfort. The holders here play a clear role; built to last with exceptional stability. The beauty and strength of wood is visible in the expressive shapes of the elements, additionally accentuated by unexpected contrasts in the material, tones, colour, in the details changing and enriching the character of the piece. Invito is a collection of unassuming aesthetics, of finely crafted simple forms and of a strong character.

PRODUCTION PROCESS

Tables are crafted from carefully selected, high-quality solid wood, chosen for its durability and distinctive natural grain. Each piece of wood is precisely cut and shaped to achieve clean lines and balanced proportions. Skilled artisans meticulously assemble the components using traditional joinery techniques, ensuring lasting strength and stability. Surfaces are finely sanded to enhance the wood's texture and prepare it for finishing. The final stage involves applying a chosen finish - whether natural oil, wax, or another treatment - to protect the wood and highlight its organic beauty. The result is a versatile, handcrafted table that seamlessly blends functionality with timeless design.

PRODUCT TYPE

Table

USAGE

Indoor

DISMANTLING OPTION

No

GLIDERS

Felt pads

STOCK ITEMS

No

COUNTRY OF ORIGIN

BiH

NOTE

Mega lengths and between sizes possible. For lengths over 300 cm, a detachable **fifth leg** is required.
Other modifications and prices on request.
The listed weights are approximate; the weight of each piece depends on its dimensions and the type of wood.

DIMENSIONS

Height: 76 cm / 29.92 in
Width: 120 - 220 cm / 47.24 - 86.61 in
Depth: 94 - 104 cm / 37 - 40.94 in
Top thickness: 2 cm / 0.79 in
Visually: 7,5 cm / 2.95 in
Leg dimensions: bottom 11x9,7 cm / 4.33x3.82 in
top 5,8x4 cm / 2.28x1.57 in

PACKAGING

Stretch wrap + five-layer cardboard box.
1 piece

PACKAGING DIMENSIONS

Height: 80 cm/31.49 in
Width: 165-225 cm/64.96-88.5 in
Depth: 100-110 cm/39.37-43.30 in

WEIGHT

Weight: 72 - 112 kg
Packaging: 2 - 5 kg

WOOD

Oak, American and European walnut, elm, cherry, maple, ash

TABLE TOP

Solid wood

TABLE BASE

Solid wood

WOOD FINISHES

Available in a variety of natural oil and soap finishes.
More information at artisan.ba/materials

TABLE TOP AND BASE FINISHES

Available in a variety of natural oil and soap finishes.
More information at artisan.ba/materials

CLEANING INSTRUCTIONS

Please download our material care & cleaning instructions through artisan.ba/materials

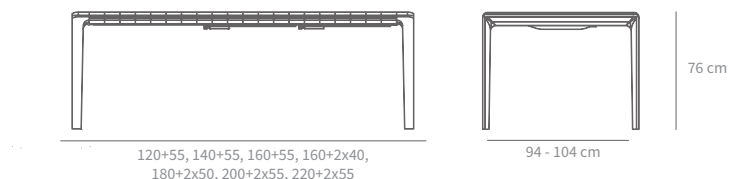

DESCRIPTION

The Invito collection is defined by robust beauty, insisting on strong forms, effected with solid and compact basic material – wood. Simple, powerful, finely proportioned forms seem reliable, evoke durability, resistance and comfort. The holders here play a clear role; built to last with exceptional stability. The beauty and strength of wood is visible in the expressive shapes of the elements, additionally accentuated by unexpected contrasts in the material, tones, colour, in the details changing and enriching the character of the piece. Invito is a collection of unassuming aesthetics, of finely crafted simple forms and of a strong character.

PRODUCTION PROCESS

Tables are crafted from carefully selected, high-quality solid wood, chosen for its durability and distinctive natural grain. Each piece of wood is precisely cut and shaped to achieve clean lines and balanced proportions. Skilled artisans meticulously assemble the components using traditional joinery techniques, ensuring lasting strength and stability. Surfaces are finely sanded to enhance the wood's texture and prepare it for finishing. The final stage involves applying a chosen finish - whether natural oil, wax, or another treatment - to protect the wood and highlight its organic beauty. The result is a versatile, handcrafted table that seamlessly blends functionality with timeless design.

PRODUCT TYPE

Extension table

USAGE

Indoor

DISMANTLING OPTION

Yes

GLIDERS

Felt pads + wheels on the movable part

STOCK ITEMS

No

COUNTRY OF ORIGIN

BiH

NOTE

Tolerance for hanging of the table:
Lengths of 160, 180, 200 cm, hanging max: 1,5 cm/ 0.59 in. Lengths of 200, 220 cm, hanging max: 2 cm/ 0.79 in.
The listed weights are approximate; the weight of each piece depends on its dimensions and the type of wood.

DIMENSIONS

Height: 76 cm/ 29.92 in
Width: 120+55, 140+55, 160+55, 160+2x40, 180+2x50, 200+2x55, 220+2x55/ 47.24+21.65, 55.12+21.65, 62.99+21.65, 62.99+2x15.75, 70.87+2x19.69, 78.74+2x21.65, 86.61+2x21.65 in
Extension dimensions: 1x55, 2x40, 2x50, 2x55/ 1x21.65, 2x15.75, 2x19.68, 2x21.65 in
Depth: 94 - 104 cm/ 37 - 40.94 in
Top thickness: 2 cm/ 0.79 in
Visually: 7,5 cm/ 2.95 in
Leg dimensions: bottom 11x9,7 cm/ 4.33x3.82 in
top 5,8x4 cm/ 2.28x1.57 in

PACKAGING

Stretch wrap + five-layer cardboard box.
1 piece

PACKAGING DIMENSIONS

Height: 80 cm/31.49 in
Width: 165-225 cm/64.96-88.5 in
Depth: 100-110 cm/39.37-43.30 in

WEIGHT

Weight: 63 - 118 kg
Packaging: 2 - 5 kg

WOOD

Oak, American and European walnut, elm, cherry, maple, ash

TABLE TOP

Solid wood

TABLE BASE

Solid wood

WOOD FINISHES

Available in a variety of natural oil and soap finishes.
More information at artisan.ba/materials

TABLE TOP AND BASE FINISHES

Available in a variety of natural oil and soap finishes.
More information at artisan.ba/materials

CLEANING INSTRUCTIONS

Please download our material care & cleaning instructions through artisan.ba/materials

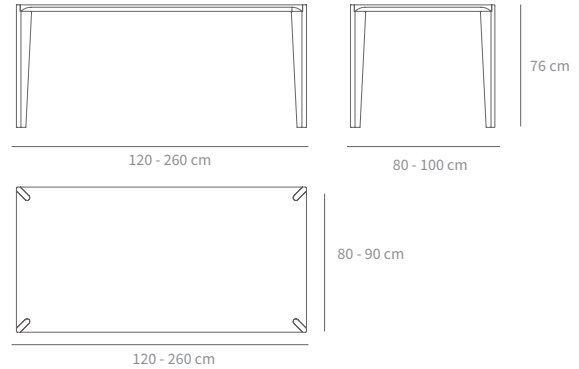

H 76 W 120, 140, 160, 180, 200, 220, 240, 260 D 80, 90, 100

DESCRIPTION

The Hanny table is a timeless fusion of contemporary design and traditional craftsmanship. One of the first pieces created by Artisan, it beautifully showcases the organic beauty of wood, with clean, sharp lines that enhance its elegant form. Meticulously crafted and manually assembled, the table highlights the natural grain of the wood, offering both style and function. Its refined design makes it a versatile centerpiece for any space, embodying Artisan's commitment to quality and timeless appeal.

PRODUCTION PROCESS

Tables are crafted from carefully selected, high-quality solid wood, chosen for its durability and distinctive natural grain. Each piece of wood is precisely cut and shaped to achieve clean lines and balanced proportions. Skilled artisans meticulously assemble the components using traditional joinery techniques, ensuring lasting strength and stability. Surfaces are finely sanded to enhance the wood's texture and prepare it for finishing. The final stage involves applying a chosen finish - whether natural oil, wax, or another treatment - to protect the wood and highlight its organic beauty. The result is a versatile, handcrafted table that seamlessly blends functionality with timeless design.

PRODUCT TYPE

Table

USAGE

Indoor

DISMANTLING OPTION

No

GLIDERS

Felt pads

STOCK ITEMS

No

COUNTRY OF ORIGIN

BiH

NOTE

Mega lengths and between sizes possible. For lengths over 270 cm, a detachable **fifth leg** is required. Other modifications and prices on request.

The listed weights are approximate; the weight of each piece depends on its dimensions and the type of wood.

DIMENSIONS

Height: 76 cm/ 29.92 in

Width: 120 - 260 cm/ 47.24 - 102.36 in

Depth: 80, 90, 100 cm/ 31.5, 35.43, 39.37 in

Top thickness: 4 cm/ 1.57 in

Visually: 4 cm/ 1.57 in

Leg dimensions: bottom 6x4 cm/ 2.36x1.57 in
top 11x4 cm/ 4.33x1.57 in

PACKAGING

Stretch wrap + five-layer cardboard box.

1 piece

PACKAGING DIMENSIONS

Height: 80 cm / 31.49 in

Width: 125 - 265 cm/ 49.21 - 104.33 in

Depth: 85 - 105 cm/ 33.46 - 41.34 in

WEIGHT

Weight: 38-71 kg

Packaging: 2-5 kg

WOOD

Oak, American and European walnut, elm, cherry, maple, ash

TABLE TOP

Solid wood

TABLE BASE

Solid wood

WOOD FINISHES

Available in a variety of natural oil and soap finishes.

More information at artisan.ba/materials

TABLE TOP AND BASE FINISHES

Available in a variety of natural oil and soap finishes.

More information at artisan.ba/materials

CLEANING INSTRUCTIONS

Please download our material care & cleaning instructions through artisan.ba/materials

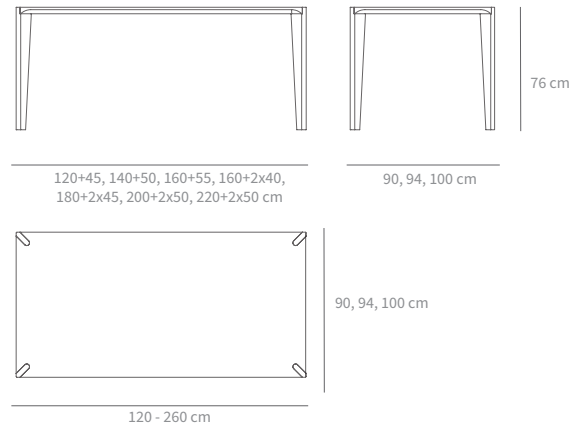

DESCRIPTION

The Hanny table is a timeless fusion of contemporary design and traditional craftsmanship. One of the first pieces created by Artisan, it beautifully showcases the organic beauty of wood, with clean, sharp lines that enhance its elegant form. Meticulously crafted and manually assembled, the table highlights the natural grain of the wood, offering both style and function. Its refined design makes it a versatile centerpiece for any space, embodying Artisan's commitment to quality and timeless appeal.

PRODUCTION PROCESS

Tables are crafted from carefully selected, high-quality solid wood, chosen for its durability and distinctive natural grain. Each piece of wood is precisely cut and shaped to achieve clean lines and balanced proportions. Skilled artisans meticulously assemble the components using traditional joinery techniques, ensuring lasting strength and stability. Surfaces are finely sanded to enhance the wood's texture and prepare it for finishing. The final stage involves applying a chosen finish - whether natural oil, wax, or another treatment - to protect the wood and highlight its organic beauty. The result is a versatile, handcrafted table that seamlessly blends functionality with timeless design.

PRODUCT TYPE

Extension table

USAGE

Indoor

DISMANTLING OPTION

Yes

GLIDERS

Felt pads + wheels on the movable part

STOCK ITEMS

No

COUNTRY OF ORIGIN

BiH

NOTE

Tolerance for hanging of the table:

Lengths of 160, 180, 200 cm, hanging max: 1,5 cm/ 0.59 in. Lengths of 200, 220 cm, hanging max: 2 cm/ 0.79 in.

The listed weights are approximate; the weight of each piece depends on its dimensions and the type of wood.

DIMENSIONS

Height: 76 cm/ 29.92 in

Width: 120+45, 140+50, 160+55, 160+2x40, 180+2x45, 200+2x50, 220+2x50/ 47.24+17.72, 55.12+19.69, 62.99+21.65, 62.99+2x15.75, 70.87+2x17.72, 78.74+2x19.69, 86.61+2x19.69 in

Depth: 90, 94, 100 cm/ 35.43, 37, 39.37 in

Extension dimensions: 1x45, 1x50, 1x55, 2x40, 2x45 and 2x50 cm/ 1x17.72, 1x19.69, 1x21.65, 2x17.72, 2x19.69

Top thickness: 2 cm/ 0.78 in

Visually: 9 cm/ 3.54 in

Leg dimensions: bottom 5x4 cm/ 1.97x1.57 in
top 11x8 cm/ 4.33x3.15 in

PACKAGING

Stretch wrap + five-layer cardboard box.

1 piece

PACKAGING DIMENSIONS

Height: 80 cm / 31.49 in

Width: 125 - 265 cm/ 49.21 - 104.33 in

Depth: 95 - 110 cm/ 37.40 - 43.30 in

WEIGHT

Weight: 62-95 kg

Packaging: 3 - 5 kg

WOOD

Oak, American and European walnut, elm, cherry, maple, ash

TABLE TOP

Solid wood

TABLE BASE

Solid wood

WOOD FINISHES

Available in a variety of natural oil and soap finishes.

More information at artisan.ba/materials

TABLE TOP AND BASE FINISHES

Available in a variety of natural oil and soap finishes.

More information at artisan.ba/materials

CLEANING INSTRUCTIONS

Please download our material care & cleaning instructions through artisan.ba/materials

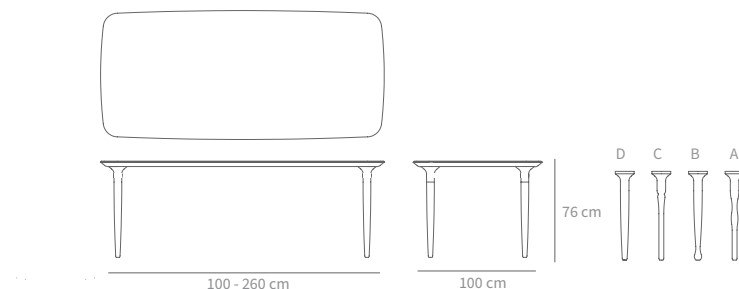

H 75 D 100 W 100, 160, 180, 200, 220, 240, 260 CM

DESCRIPTION

The Pasha table, designed by Zoran Jedrejčić, is distinguished by its modern, minimalist lines, making it a versatile addition to various settings. One of its most unique features is the asymmetric leg design; each of the four legs is crafted in a different shape, adding a dynamic and personalised touch to the piece. This thoughtful design element allows users to select their preferred leg style, offering a customisable experience that enhances its appeal. Available in multiple wood finishes and seven different sizes, the Pasha table combines functionality with artistic expression, reflecting a harmonious blend of contemporary aesthetics and traditional craftsmanship.

PRODUCTION PROCESS

Tables are crafted from carefully selected, high-quality solid wood, chosen for its durability and distinctive natural grain. Each piece of wood is precisely cut and shaped to achieve clean lines and balanced proportions. Skilled artisans meticulously assemble the components using traditional joinery techniques, ensuring lasting strength and stability. Surfaces are finely sanded to enhance the wood's texture and prepare it for finishing. The final stage involves applying a chosen finish - whether natural oil, wax, or another treatment - to protect the wood and highlight its organic beauty. The result is a versatile, handcrafted table that seamlessly blends functionality with timeless design.

PRODUCT TYPE

Table

USAGE

Indoor

DISMANTLING OPTION

Yes (on request)

GLIDERS

Felt pads

STOCK ITEMS

No

COUNTRY OF ORIGIN

BiH

NOTE

Mega lengths and between sizes possible. For lengths over 270 cm, a detachable **fifth leg** is required. Other modifications and prices on request. You can choose between 4 different types of legs.

The listed weights are approximate; the weight of each piece depends on its dimensions and the type of wood.

DIMENSIONS

Height: 76 cm/ 29.92 in
Width: 100 - 260 cm/ 39.37- 102.36 in
Depth: 100 cm/ 39.37 in
Top thickness: 4,2 cm/ 1.65 in

PACKAGING

Stretch wrap + five-layer cardboard box.
1 piece

PACKAGING DIMENSIONS

Height: 80 cm / 31.49 in
Width: 105 - 265 cm/ 41.33 - 104.33 in
Depth: 85 - 105 cm/ 33.46 - 41.33 in

WEIGHT

Weight: 45-95 kg
Packaging: 3-5 kg

WOOD

Oak, American and European walnut, elm, cherry, maple, ash

TABLE TOP

Solid wood

TABLE BASE

Solid wood

WOOD FINISHES

Available in a variety of natural oil and soap finishes.

More information at artisan.ba/materials

TABLE TOP AND BASE FINISHES

Available in a variety of natural oil and soap finishes.

More information at artisan.ba/materials

CLEANING INSTRUCTIONS

Please download our material care & cleaning instructions through artisan.ba/materials

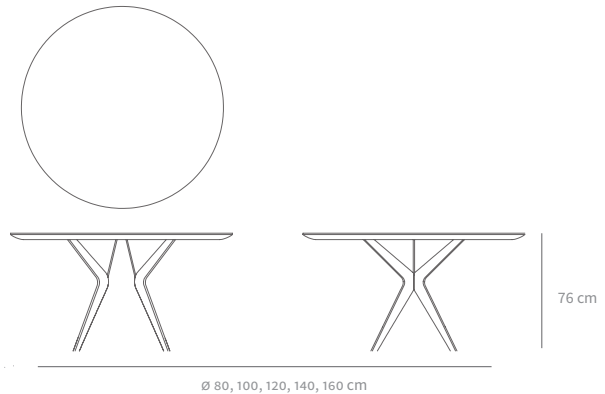

DESCRIPTION

Lakri round table combines a soft circular tabletop with a striking base design. The sharply angled legs form a sculptural structure that both supports and defines the table's character. Positioned slightly inward from the edge, the legs create an open and airy space around the table, allowing for comfortable seating and movement. The stable yet elegant form makes Lakri not only functional but also a central visual element in any room. Its circular shape encourages interaction and creates a warm, inviting atmosphere - ideal for gatherings, shared meals, or conversations. The Lakri round table is a perfect balance of solid craftsmanship and refined aesthetics.

PRODUCTION PROCESS

Tables are crafted from carefully selected, high-quality solid wood, chosen for its durability and distinctive natural grain. Each piece of wood is precisely cut and shaped to achieve clean lines and balanced proportions. Skilled artisans meticulously assemble the components using traditional joinery techniques, ensuring lasting strength and stability. Surfaces are finely sanded to enhance the wood's texture and prepare it for finishing. The final stage involves applying a chosen finish - whether natural oil, wax, or another treatment - to protect the wood and highlight its organic beauty. The result is a versatile, handcrafted table that seamlessly blends functionality with timeless design.

PRODUCT TYPE

Table

USAGE

Indoor

DISMANTLING OPTION

Yes

GLIDERS

Felt pads

STOCK ITEMS

No

COUNTRY OF ORIGIN

BiH

NOTE

Other modifications and prices on request.
The listed weights are approximate; the weight of each piece depends on its dimensions and the type of wood.

DIMENSIONS

Height: 76 cm/ 29.53 in
Diameter: 80,100, 120, 140, 160 cm/ 31.49, 39.37,47.24 - 55.12, 62.99 in
Top thickness: 4 cm/ 1.57 in
Visually: 4 cm/ 1.57 in

PACKAGING

Stretch wrap + five-layer cardboard box.
1 piece

PACKAGING DIMENSIONS

Height: 80/ 31.49 in
Width: 125-145 cm/ 49.21- 57.08 in
Depth: 125-145/ 49.21- 57.08 in
Dismantling packaging dimensions on request.

WEIGHT

Weight: 30-59 kg
Packaging: 3 - 5.5 kg

WOOD

Oak, American and European walnut, elm, cherry, maple, ash

TABLE TOP

Solid wood

TABLE BASE

Solid wood

WOOD FINISHES

Available in a variety of natural oil and soap finishes.
More information at artisan.ba/materials

TABLE TOP AND BASE FINISHES

Available in a variety of natural oil and soap finishes.
More information at artisan.ba/materials

CLEANING INSTRUCTIONS

Please download our material care & cleaning instructions through artisan.ba/materials

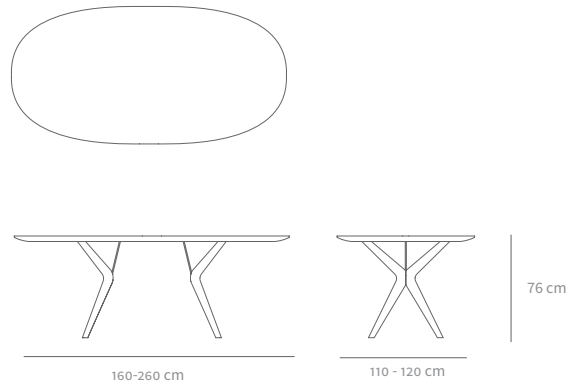

H 76 160 × 110, 180 × 110, 200 × 110, 220 × 110, 240 × 110, 260 × 110,
165 × 120, 180 × 120, 205 × 120, 220 × 120, 240 × 120, 260 × 120 CM

DESCRIPTION

The Lakri oval table combines a soft, oval tabletop with a striking, angular leg design. The legs bend sharply and meet in a dynamic shape that narrows toward the center and widens again toward the floor, providing both stability and open space. This sculptural base enhances the visual appeal while allowing room for movement around the table. The table can transform from circular to oval, offering flexibility in size and layout. Its elegant form makes it a perfect centerpiece for gatherings and conversations, adding both function and beauty to any space.

PRODUCTION PROCESS

Tables are crafted from carefully selected, high-quality solid wood, chosen for its durability and distinctive natural grain. Each piece of wood is precisely cut and shaped to achieve clean lines and balanced proportions. Skilled artisans meticulously assemble the components using traditional joinery techniques, ensuring lasting strength and stability. Surfaces are finely sanded to enhance the wood's texture and prepare it for finishing. The final stage involves applying a chosen finish - whether natural oil, wax, or another treatment - to protect the wood and highlight its organic beauty. The result is a versatile, handcrafted table that seamlessly blends functionality with timeless design.

PRODUCT TYPE

Table

USAGE

Indoor

DISMANTLING OPTION

Yes

GLIDERS

Felt pads

STOCK ITEMS

No

COUNTRY OF ORIGIN

BiH

NOTE

Other modifications and prices on request.
The listed weights are approximate; the weight of each piece depends on its dimensions and the type of wood.

DIMENSIONS

Height: 76 cm/ 29.13 in
Width: 160 - 260 cm/ 62.99 - 102.36 in
Depth: 110 - 120 cm/ 43.31 - 47.24 in
Top thickness: 4 cm/ 1.57 in
4 cm/ 1.57 in

PACKAGING

Stretch wrap + five-layer cardboard box.
1 piece

PACKAGING DIMENSIONS

Height: 80 cm / 31.49 in
Width: 165 - 265 cm/ 64,96- 104.33 in
Depth: 115 - 125 cm/ 45.27 - 49.21 in
Dismantling packaging dimensions on request.

WEIGHT

Weight: 51-81 kg
Packaging: 3 - 7.5 kg

WOOD

Oak, American and European walnut, elm, cherry, maple, ash

TABLE TOP

Solid wood

TABLE BASE

Solid wood

WOOD FINISHES

Available in a variety of natural oil and soap finishes.

More information at artisan.ba/materials

TABLE TOP AND BASE FINISHES

Available in a variety of natural oil and soap finishes.

More information at artisan.ba/materials

CLEANING INSTRUCTIONS

Please download our material care & cleaning instructions through artisan.ba/materials

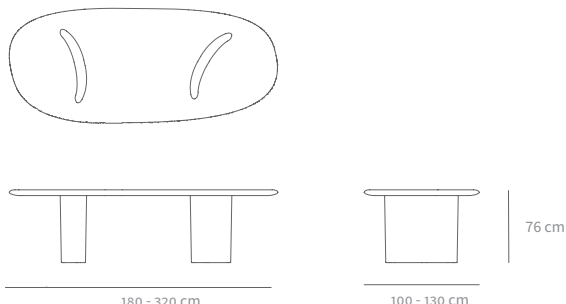

H76 W180, 200, 220, 240, 260, 280, 300, 320 D 100,110, 120, 130 CM

DESCRIPTION

The Monument table seamlessly blends functionality with sculptural artistry, transforming any space with its minimalist yet striking design. Crafted from sustainably sourced wood, it stands as a testament to both durability and timeless elegance. The table's distinctive design features a uniquely shaped top and legs positioned at varying angles, creating a dynamic appearance from every viewpoint. Offered in a selection of wood finishes, the Monument table can be customized to suit a variety of interior aesthetics. This piece embodies Artisan's commitment to innovative design and exceptional craftsmanship, making it a bold and unforgettable addition to any environment.

PRODUCTION PROCESS

Tables are crafted from carefully selected, high-quality solid wood, chosen for its durability and distinctive natural grain. Each piece of wood is precisely cut and shaped to achieve clean lines and balanced proportions. Skilled artisans meticulously assemble the components using traditional joinery techniques, ensuring lasting strength and stability. Surfaces are finely sanded to enhance the wood's texture and prepare it for finishing. The final stage involves applying a chosen finish - whether natural oil, wax, or another treatment - to protect the wood and highlight its organic beauty. The result is a versatile, handcrafted table that seamlessly blends functionality with timeless design.

PRODUCT TYPE

Table

USAGE

Indoor

DISMANTLING OPTION

Yes

GLIDERS

Felt pads

STOCK ITEMS

No

COUNTRY OF ORIGIN

BiH

NOTE

Mega lengths and between sizes possible.
Other modifications and prices on request.
The listed weights are approximate; the weight of each piece depends on its dimensions and the type of wood.

DIMENSIONS

Height: 76 cm/ 29.92 in
Width: 180 - 320 cm/ 70.87 - 125.98 in
Depth: 100,110,120,130 cm/ 39.37,43.31,47.24, 51.18 in
Top thickness: 6 cm/ 2.36 in
Visually: 6 cm/ 2.36 in

PACKAGING

Stretch wrap + five-layer cardboard box.
1 piece

PACKAGING DIMENSIONS

Height: 80 cm/ 31.49 in
Width: 185-325cm/ 72.83-127.95 in
Depth: 115-135 / 45.27-53.14 in
Dismantling packaging dimensions on request.

WEIGHT

Weight: 80-220kg
Packaging: 5- 7.5 kg

WOOD

Oak, American and European walnut, elm, cherry, maple, ash

TABLE TOP

Solid wood

TABLE BASE

Solid wood

WOOD FINISHES

Available in a variety of natural oil and soap finishes.
More information at artisan.ba/materials

TABLE TOP AND BASE FINISHES

Available in a variety of natural oil and soap finishes.
More information at artisan.ba/materials

CLEANING INSTRUCTIONS

Please download our material care & cleaning instructions through artisan.ba/materials

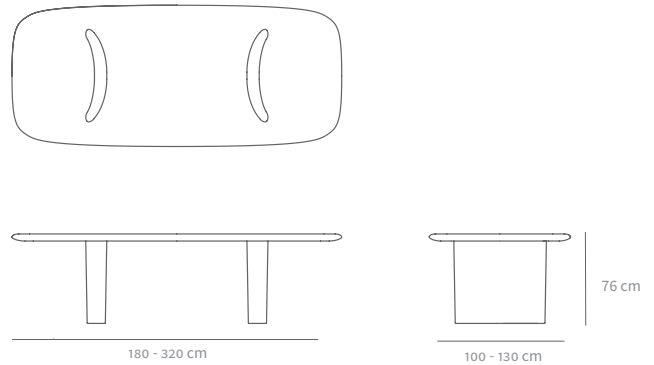

H 76 W 180, 200, 220, 240, 260, 280, 300, 320 D 100, 110, 120, 130 CM

DESCRIPTION

The Monument table seamlessly blends functionality with sculptural artistry, transforming any space with its minimalist yet striking design. Crafted from sustainably sourced wood, it stands as a testament to both durability and timeless elegance. The table's distinctive design features a uniquely shaped top and legs positioned at varying angles, creating a dynamic appearance from every viewpoint. Offered in a selection of wood finishes, the Monument table can be customized to suit a variety of interior aesthetics. This piece embodies Artisan's commitment to innovative design and exceptional craftsmanship, making it a bold and unforgettable addition to any environment.

PRODUCTION PROCESS

Tables are crafted from carefully selected, high-quality solid wood, chosen for its durability and distinctive natural grain. Each piece of wood is precisely cut and shaped to achieve clean lines and balanced proportions. Skilled artisans meticulously assemble the components using traditional joinery techniques, ensuring lasting strength and stability. Surfaces are finely sanded to enhance the wood's texture and prepare it for finishing. The final stage involves applying a chosen finish - whether natural oil, wax, or another treatment - to protect the wood and highlight its organic beauty. The result is a versatile, handcrafted table that seamlessly blends functionality with timeless design.

PRODUCT TYPE

Table

USAGE

Indoor

DISMANTLING OPTION

Yes

GLIDERS

Felt pads

STOCK ITEMS

No

COUNTRY OF ORIGIN

BiH

NOTE

Mega lengths and between sizes possible.
Other modifications and prices on request.
The listed weights are approximate; the weight of each piece depends on its dimensions and the type of wood.

DIMENSIONS

Height: 76 cm/ 29.92 in
Width: 180 - 320 cm/ 70.87 - 125.98 in
Depth: 100,110,120,130 cm/ 39.37,43.31,47.24, 51.18 in
Top thickness: 6 cm/ 2.36 in
Visually: 6 cm/ 2.36 in

PACKAGING

Stretch wrap + five-layer cardboard box.
1 piece

PACKAGING DIMENSIONS

Height: 80 cm/ 31.49 in
Width: 125 - 325 cm/ 49,21 - 127,95 in
Depth: 115 - 135 cm/ 45.27 - 53.14 in
Dismantling packaging dimensions on request.

WEIGHT

Weight: 80-220 kg
Packaging: 5 - 7.5 kg

WOOD

Oak, American and European walnut, elm, cherry, maple, ash

TABLE TOP

Solid wood

TABLE BASE

Solid wood

WOOD FINISHES

Available in a variety of natural oil and soap finishes.
More information at artisan.ba/materials

TABLE TOP AND BASE FINISHES

Available in a variety of natural oil and soap finishes.
More information at artisan.ba/materials

CLEANING INSTRUCTIONS

Please download our material care & cleaning instructions through artisan.ba/materials

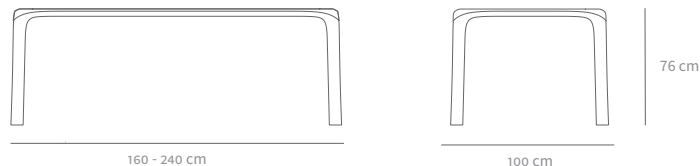

H 76 W 160, 180, 200, 220, 240 D 100 cm

DESCRIPTION

The design of the Ging table embodies modern, timeless, and minimal aesthetics. Its clean lines and understated elegance make it an ideal addition to any contemporary space. The table's balanced proportions and refined surface create a harmonious focal point, effortlessly complementing a variety of interior styles. Paired with the Ging chair, the combination creates a cohesive and sophisticated setting, elevating both comfort and aesthetics. Whether used in a dining room, office, or as an accent piece, the Ging table offers both versatility and style, seamlessly blending functionality with design simplicity.

PRODUCTION PROCESS

Tables are crafted from carefully selected, high-quality solid wood, chosen for its durability and distinctive natural grain. Each piece of wood is precisely cut and shaped to achieve clean lines and balanced proportions. Skilled artisans meticulously assemble the components using traditional joinery techniques, ensuring lasting strength and stability. Surfaces are finely sanded to enhance the wood's texture and prepare it for finishing. The final stage involves applying a chosen finish - whether natural oil, wax, or another treatment - to protect the wood and highlight its organic beauty. The result is a versatile, handcrafted table that seamlessly blends functionality with timeless design.

PRODUCT TYPE

Table

USAGE

Indoor

DISMANTLING OPTION

No

GLIDERS

Felt pads

STOCK ITEMS

No

COUNTRY OF ORIGIN

BiH

NOTE

Mega lengths and between sizes possible. For lengths over 270 cm, a detachable **fifth leg** is required. Other modifications and prices on request.

The listed weights are approximate; the weight of each piece depends on its dimensions and the type of wood.

DIMENSIONS

Height: 76 cm/ 29.92 in
Width: 160 - 240 cm/ 62.99 - 94.49 in
Depth: 100 cm/ 39.37 in
Top thickness: 4 cm/ 1.57 in
Visually: 4 cm/ 1.57 in
Leg diameter: bottom 7.5 cm/ 2.95 in

PACKAGING

Stretch wrap + five-layer cardboard box.
1 piece

PACKAGING DIMENSIONS

Height: 81 cm/ 31.89 in
Width: 165 - 245 cm/ 64.96 - 96.45 in
Depth: 105 cm/ 41.33 in

WEIGHT

Weight: 49 - 63 kg
Packaging: 3 - 5 kg

WOOD

Oak, American and European walnut, elm, cherry, maple, ash

TABLE TOP

Solid wood

TABLE BASE

Solid wood

WOOD FINISHES

Available in a variety of natural oil and soap finishes.

More information at artisan.ba/materials

TABLE TOP AND BASE FINISHES

Available in a variety of natural oil and soap finishes.

More information at artisan.ba/materials

CLEANING INSTRUCTIONS

Please download our material care & cleaning instructions through artisan.ba/materials

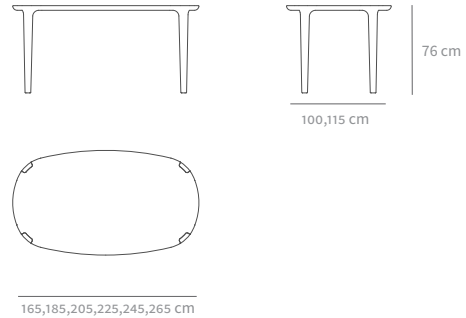

DESCRIPTION

The Wu collection is a family of solid wood furniture where the strength and warmth of the wood meet exceptionally smooth, refined design. Each piece combines timeless craftsmanship with modern elegance, creating a harmonious balance between functionality and aesthetic appeal. The intricate details of the joints between the wide seat, soft legs, and comfortable backrest make this collection both unique and original, ensuring a distinctive look that stands out in any space. These thoughtful design elements are consistently maintained and beautifully developed across the entire collection, creating a cohesive family of furniture. The Wu collection embodies both elegance and durability, offering pieces that are not only visually striking but also crafted to provide long-lasting comfort and support. Perfect for a variety of interiors, this collection exemplifies versatility, comfort, and attention to detail.

PRODUCTION PROCESS

Tables are crafted from carefully selected, high-quality solid wood, chosen for its durability and distinctive natural grain. Each piece of wood is precisely cut and shaped to achieve clean lines and balanced proportions. Skilled artisans meticulously assemble the components using traditional joinery techniques, ensuring lasting strength and stability. Surfaces are finely sanded to enhance the wood's texture and prepare it for finishing. The final stage involves applying a chosen finish - whether natural oil, wax, or another treatment - to protect the wood and highlight its organic beauty. The result is a versatile, handcrafted table that seamlessly blends functionality with timeless design.

PRODUCT TYPE

Table

USAGE

Indoor

DISMANTLING OPTION

No

GLIDERS

Felt pads

STOCK ITEMS

No

COUNTRY OF ORIGIN

BiH

NOTE

Mega lengths and between sizes possible. For lengths over 270 cm, a detachable **fifth leg** is required. Other modifications and prices on request.
The listed weights are approximate; the weight of each piece depends on its dimensions and the type of wood.

DIMENSIONS

Height: 76 cm/ 29.92 in
Width: 165 - 265 cm/ 64.96 - 104.33 in
Depth: 100, 115 cm/ 39.37 - 45.28 in

PACKAGING

Stretch wrap + five-layer cardboard box.
1 piece

PACKAGING DIMENSIONS

Height: 81 cm/ 31.89 in
Width: 175- 275 cm/ 68.92 - 108.27 in
Depth: 110 - 125 cm/ 43.31 - 49.21 in

WEIGHT

Weight: 50-120 kg
Packaging: 3 - 7.5 kg

WOOD

Oak, American and European walnut, elm, cherry, maple, ash

TABLE TOP

Solid wood

TABLE BASE

Solid wood

WOOD FINISHES

Available in a variety of natural oil and soap finishes.

More information at artisan.ba/materials

TABLE TOP AND BASE FINISHES

Available in a variety of natural oil and soap finishes.

More information at artisan.ba/materials

CLEANING INSTRUCTIONS

Please download our material care & cleaning instructions through artisan.ba/materials

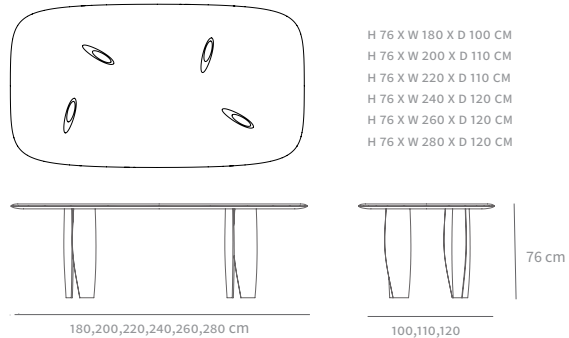

DESCRIPTION

A key piece in the collection of the same name, alongside the Nila chair, the Nilu table unveils a modern, light, and intriguing design, meticulously hand-finished by our skilled craftsmen. With its delicate yet robust structure, the table combines contemporary elegance with exceptional functionality. The clean, flowing lines of the tabletop, paired with a thoughtfully designed base, create a piece that is visually striking and effortlessly adaptable to various settings. Crafted from sustainably sourced wood, the Nilu table emphasises the beauty of natural materials, ensuring durability while maintaining a lightweight appearance. Its minimalistic form makes it versatile enough for both residential and commercial spaces, while the finely executed craftsmanship adds a sense of luxury to any environment.

PRODUCTION PROCESS

Tables are crafted from carefully selected, high-quality solid wood, chosen for its durability and distinctive natural grain. Each piece of wood is precisely cut and shaped to achieve clean lines and balanced proportions. Skilled artisans meticulously assemble the components using traditional joinery techniques, ensuring lasting strength and stability. Surfaces are finely sanded to enhance the wood's texture and prepare it for finishing. The final stage involves applying a chosen finish - whether natural oil, wax, or another treatment - to protect the wood and highlight its organic beauty. The result is a versatile, handcrafted table that seamlessly blends functionality with timeless design.

PRODUCT TYPE

Table

USAGE

Indoor

DISMANTLING OPTION

Yes

GLIDERS

Felt pads

STOCK ITEMS

No

COUNTRY OF ORIGIN

BiH

NOTE

Mega lengths and between sizes possible. For lengths over 300 cm, a detachable **fifth leg** is required. Other modifications and prices on request.

The listed weights are approximate; the weight of each piece depends on its dimensions and the type of wood.

DIMENSIONS

Height: 76 cm/ 29.92 in
Width: 180 - 280 cm/ 70.87 - 110.24 in
Depth: 100 - 120 cm/ 39.37 - 47.24 in
Top thickness: 4 cm/ 1.57 in
Visually: 4 cm/ 1.57 in
Leg diameter: - bottom 4 cm/ 1.57 in
- middle 5.3 cm/ 2.087 in
- top 4 cm/ 1.57 in

PACKAGING

Stretch wrap + five-layer cardboard box.
1 piece

PACKAGING DIMENSIONS

Height: 81 cm/ 31.89 in
Width: 185 - 285 cm/ 72.83 - 112.21 in
Depth: 105 - 125 cm/ 41.33 - 49.21 in
Dismantling packaging dimensions on request.

WEIGHT

Weight: 50-110 kg
Packaging: 3 - 7.5 kg

WOOD

Oak, American and European walnut, elm, cherry, maple, ash

TABLE TOP

Solid wood

TABLE BASE

Solid wood

WOOD FINISHES

Available in a variety of natural oil and soap finishes.

More information at artisan.ba/materials

TABLE TOP AND BASE FINISHES

Available in a variety of natural oil and soap finishes.

More information at artisan.ba/materials

CLEANING INSTRUCTIONS

Please download our material care & cleaning instructions through artisan.ba/materials

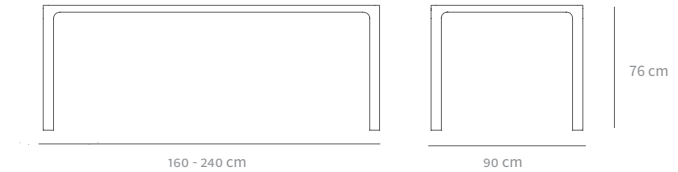

H 76 W 160, 180, 200, 220, 240 D 90 CM

DESCRIPTION

The Jean table is the perfect blend of linear elegance and functional design, effortlessly fitting into any space and creating a comfortable, welcoming atmosphere. Its refined simplicity makes it a versatile addition to a variety of interiors, while its graceful lines exude a sense of understated sophistication. Highly customisable with a selection of fine finishes, the Jean table can suit your unique space and style. Each Artisan creation is a unique expression of emotion and craftsmanship, offering a daily experience of beauty and functionality. Whether in a dining room, office, or living area, this table serves as a timeless focal point, adding a touch of elegance to any environment.

PRODUCTION PROCESS

Tables are crafted from carefully selected, high-quality solid wood, chosen for its durability and distinctive natural grain. Each piece of wood is precisely cut and shaped to achieve clean lines and balanced proportions. Skilled artisans meticulously assemble the components using traditional joinery techniques, ensuring lasting strength and stability. Surfaces are finely sanded to enhance the wood's texture and prepare it for finishing. The final stage involves applying a chosen finish - whether natural oil, wax, or another treatment - to protect the wood and highlight its organic beauty. The result is a versatile, handcrafted table that seamlessly blends functionality with timeless design.

PRODUCT TYPE

Table

USAGE

Indoor

DISMANTLING OPTION

Yes

GLIDERS

Felt pads

STOCK ITEMS

No

COUNTRY OF ORIGIN

BiH

NOTE

Mega lengths and between sizes possible. For lengths over 300 cm, a detachable **fifth leg** is required. Other modifications and prices on request.

The listed weights are approximate; the weight of each piece depends on its dimensions and the type of wood.

DIMENSIONS

Height: 76 cm/ 29.92 in
Width: 160 - 240 cm/ 62.99 - 94.49 in
Depth: 90 cm/ 35.43 in
Top thickness: 4 cm/ 1.57 in
Visually: 4 cm/ 1.57 in
Leg diameter: 6 cm/ 2.36 in

PACKAGING

Stretch wrap + five-layer cardboard box.
1 piece

PACKAGING DIMENSIONS

Height: 81 cm/ 31.89 in in
Width: 165 - 245 cm/ 64.96 - 96.45 in
Depth: 95 cm/ 37.40 in
Dismantling packaging dimensions on request.

WEIGHT

Weight: 50-65 kg
Packaging: 2-3 kg

WOOD

Oak, American and European walnut, elm, cherry, maple, ash

TABLE TOP

Solid wood

TABLE BASE

Solid wood

WOOD FINISHES

Available in a variety of natural oil and soap finishes.

More information at artisan.ba/materials

TABLE TOP AND BASE FINISHES

Available in a variety of natural oil and soap finishes.

More information at artisan.ba/materials

CLEANING INSTRUCTIONS

Please download our material care & cleaning instructions through artisan.ba/materials

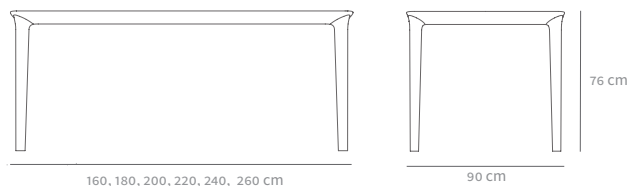

DESCRIPTION

The Tara table is a masterful piece of design that blends modern elegance with timeless functionality. Crafted from solid wood, the table features clean lines and a minimalist aesthetic that easily complements a variety of interior styles. The table's robust structure is balanced by a unique leg design, with legs tapering elegantly from the top to the base, offering both stability and refined visual appeal. One of the standout features of the Tara table is its extending mechanism. This innovative feature allows the table to be extended, adapting to different needs and making it perfect for both intimate dinners and larger gatherings. Available in a variety of sizes and finishes, the Tara table provides the versatility needed to fit seamlessly into any living or dining space. Whether you prefer a natural or lacquered finish, the craftsmanship and versatility of this table make it an exceptional addition to any home.

PRODUCTION PROCESS

Tables are crafted from carefully selected, high-quality solid wood, chosen for its durability and distinctive natural grain. Each piece of wood is precisely cut and shaped to achieve clean lines and balanced proportions. Skilled artisans meticulously assemble the components using traditional joinery techniques, ensuring lasting strength and stability. Surfaces are finely sanded to enhance the wood's texture and prepare it for finishing. The final stage involves applying a chosen finish - whether natural oil, wax, or another treatment - to protect the wood and highlight its organic beauty. The result is a versatile, handcrafted table that seamlessly blends functionality with timeless design.

PRODUCT TYPE

Table

USAGE

Indoor

DISMANTLING OPTION

Yes (only on request)

GLIDERS

Felt pads

STOCK ITEMS

No

COUNTRY OF ORIGIN

BiH

NOTE

Mega lengths and between sizes possible. For lengths over 300 cm, a detachable **fifth leg** is required. Other modifications and prices on request.

The listed weights are approximate; the weight of each piece depends on its dimensions and the type of wood.

DIMENSIONS

Height: 76 cm/ 29.92 in
Width: 160 - 260 cm/ 62.99 - 102.36 in
Depth: 90 cm/ 35.43 in
Top thickness: 2 cm/ 0.79 in
Visually: 7 cm/ 2.76 in
Leg diameter: – top 5.5x5.5 cm/ 2.16 in
– bottom 8x8 cm/ 3.14 in

PACKAGING

Stretch wrap + five-layer cardboard box.
1 piece

PACKAGING DIMENSIONS

Height: 81 cm/ 31.89 in
Width: 165 - 265 cm/ 64.96 - 104.33 in
Depth: 95 cm/ 37.40 in

WEIGHT

Weight: 50-70 kg
Packaging: 3 - 5 kg

WOOD

Oak, American and European walnut, elm, cherry, maple, ash

TABLE TOP

Solid wood

TABLE BASE

Solid wood

WOOD FINISHES

Available in a variety of natural oil and soap finishes.

More information at artisan.ba/materials

TABLE TOP AND BASE FINISHES

Available in a variety of natural oil and soap finishes.

More information at artisan.ba/materials

CLEANING INSTRUCTIONS

Please download our material care & cleaning instructions through artisan.ba/materials

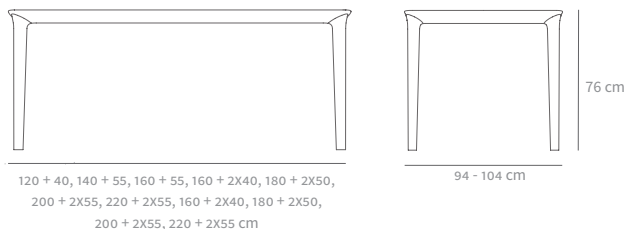

DESCRIPTION

The Tara table is a masterful piece of design that blends modern elegance with timeless functionality. Crafted from solid wood, the table features clean lines and a minimalist aesthetic that easily complements a variety of interior styles. The table's robust structure is balanced by a unique leg design, with legs tapering elegantly from the top to the base, offering both stability and refined visual appeal. One of the standout features of the Tara table is its extending mechanism. This innovative feature allows the table to be extended, adapting to different needs and making it perfect for both intimate dinners and larger gatherings. Available in a variety of sizes and finishes, the Tara table provides the versatility needed to fit seamlessly into any living or dining space. Whether you prefer a natural or lacquered finish, the craftsmanship and versatility of this table make it an exceptional addition to any home.

PRODUCTION PROCESS

Tables are crafted from carefully selected, high-quality solid wood, chosen for its durability and distinctive natural grain. Each piece of wood is precisely cut and shaped to achieve clean lines and balanced proportions. Skilled artisans meticulously assemble the components using traditional joinery techniques, ensuring lasting strength and stability. Surfaces are finely sanded to enhance the wood's texture and prepare it for finishing. The final stage involves applying a chosen finish - whether natural oil, wax, or another treatment - to protect the wood and highlight its organic beauty. The result is a versatile, handcrafted table that seamlessly blends functionality with timeless design.

PRODUCT TYPE

Extension table

USAGE

Indoor

DISMANTLING OPTION

Yes (only on request)

GLIDERS

Felt pads + wheels on the movable part

STOCK ITEMS

No

COUNTRY OF ORIGIN

BiH

NOTE

Tolerance for hanging of the table:
Lengths of 160, 180, 200 cm, hanging max: 1,5 cm/ 0.59 in. Lengths of 200, 220 cm, hanging max: 2 cm/ 0.79 in. The listed weights are approximate; the weight of each piece depends on its dimensions and the type of wood.ž

DIMENSIONS

Height: 76 cm/ 29.92 in
Width: 120+40, 140+55, 160+55, 160+2x40, 180+2x50, 200+2x55, 220+2x55, 160+2x40, 180+2x50, 200+2x55, 220+2x55 cm/ 47.24+15.75, 55.12+21.65, 62.99+21.65, 62.99+2x15.75, 70.87+2x19.69, 78.74+2x21.65, 86.61+2x21.26 in
Depth: 94, 104 cm/ 37, 104.94 in
Extension dimension: 1x40, 1x55, 2x40, 2x50, and 2x55 cm/ 1x15.75, 1x21.65, 2x15.75, 2x19.69, 2x21.65 in
Top thickness: 2 cm/ 0.79 in
Visually: 7 cm/ 2.76 in
Leg diameter: – top 5.5x5.5 cm/ 2.16 in
– bottom 8x8 cm/ 3.14 in

PACKAGING

Stretch wrap + five-layer cardboard box.
1 piece

PACKAGING DIMENSIONS

Height: 81 cm/ 31.89 in
Width: 125 - 225 cm/ 49.21- 88.58 in
Depth: 100 - 110 cm/ 39.37 - 49.3 in
Dismantling packaging dimensions on request.

WEIGHT

Weight: 76-109 kg
Packaging: 3 - 6 kg

WOOD

Oak, American and European walnut, elm, cherry, maple, ash

TABLE TOP

Solid wood

TABLE BASE

Solid wood

WOOD FINISHES

Available in a variety of natural oil and soap finishes.

More information at artisan.ba/materials

TABLE TOP AND BASE FINISHES

Available in a variety of natural oil and soap finishes.

More information at artisan.ba/materials

CLEANING INSTRUCTIONS

Please download our material care & cleaning instructions through artisan.ba/materials

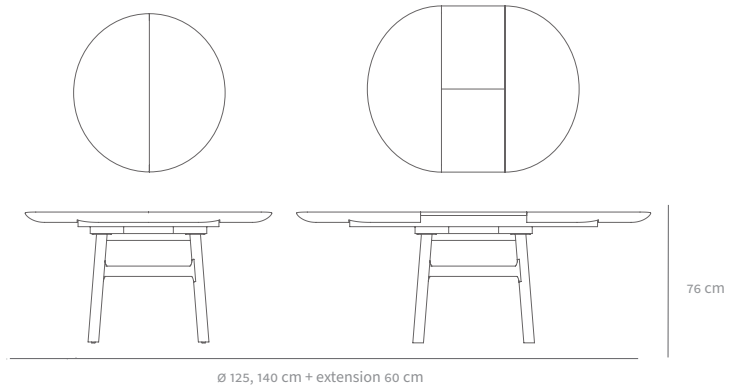

DESCRIPTION

The Dash extension table, features a seamless fusion of elegant design and practical functionality. Manufactured from sustainably sourced solid wood, it offers a smooth, round tabletop that effortlessly transforms into an oval shape through an innovative extension mechanism. The extension adds 60 cm to the table, making it perfect for accommodating additional guests. The table's clean, minimalist design is enhanced by soft, rounded edges and warm wood finishes, creating a welcoming and sophisticated presence in any space. Available in a variety of wood finishes, the Dash extension table blends versatility and timeless appeal, making it a standout piece in any dining setting.

PRODUCTION PROCESS

Tables are crafted from carefully selected, high-quality solid wood, chosen for its durability and distinctive natural grain. Each piece of wood is precisely cut and shaped to achieve clean lines and balanced proportions. Skilled artisans meticulously assemble the components using traditional joinery techniques, ensuring lasting strength and stability. Surfaces are finely sanded to enhance the wood's texture and prepare it for finishing. The final stage involves applying a chosen finish - whether natural oil, wax, or another treatment - to protect the wood and highlight its organic beauty. The result is a versatile, handcrafted table that seamlessly blends functionality with timeless design.

PRODUCT TYPE

Extension table

USAGE

Indoor

DISMANTLING OPTION

No

GLIDERS

Felt pads

STOCK ITEMS

No

COUNTRY OF ORIGIN

BiH

NOTE

The listed weights are approximate; the weight of each piece depends on its dimensions and the type of wood.

DIMENSIONS

Height: 76 cm/ 29.92 in
Width: 125, 140 cm/ 49.21, 55.12 in
Extension dimension: 60 cm/ 23.62 in
Top thickness: 6 cm/ 2.36 in
Visually: 6 cm/ 2.36 in
Leg diameter: – top 6 cm/ 2.36 in
– bottom 6 cm/ 3.14 in

PACKAGING

Stretch wrap + five-layer cardboard box.
1 piece

PACKAGING DIMENSIONS

Height: 81 cm/ 31.89 in
Width: 130 - 145 cm/ 51.18 - 53.15 in

WEIGHT

Weight: 79-94 kg
Packaging: 3 kg

WOOD

Oak, American and European walnut, elm, cherry, maple, ash

TABLE TOP

Solid wood

TABLE BASE

Solid wood

WOOD FINISHES

Available in a variety of natural oil and soap finishes.

More information at artisan.ba/materials

TABLE TOP AND BASE FINISHES

Available in a variety of natural oil and soap finishes.

More information at artisan.ba/materials

CLEANING INSTRUCTIONS

Please download our material care & cleaning instructions through artisan.ba/materials

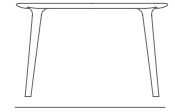
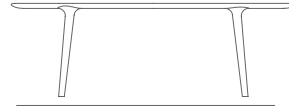
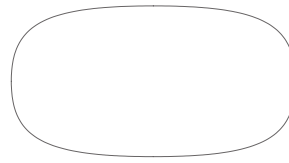

76 cm

165 - 340 cm

110, 120 cm

H 76 W 165, 185, 205, 225, 245, 265, 285, 305, 325, 340 D110, 120

DISTANCE BETWEEN THE LEGS:

- FOR WIDTH 165 IS 82 CM
- FOR WIDTH 185 IS 115 CM
- FOR WIDTH 205 IS 117 CM
- FOR WIDTH 225 IS 128 CM
- FOR WIDTH 245 IS 146 CM
- FOR WIDTH 265 IS 176 CM
- FOR WIDTH 285 IS 184 CM
- FOR WIDTH 305 IS 200 CM
- FOR WIDTH 325 IS 205 CM
- FOR WIDTH 340 IS 210 CM

DESCRIPTION

The Luc table is a refined piece of furniture that seamlessly combines functionality with sophisticated design. Its sleek shape with a 4 cm thick tabletop offers a clean, modern aesthetic. The table is supported by uniquely designed legs, adding both visual interest and structural strength. Crafted from high-quality solid wood, the Luc oval table is available in various finishes, including Oak, European or American walnut, maple, cherry, elm and ash, each highlighting the natural beauty of the material. With its adjustable length, the table can cater to various spaces and needs, making it an ideal choice for both intimate and larger gatherings. This table exemplifies Artisan's commitment to exceptional craftsmanship and timeless design, bringing elegance and versatility to any dining area.

PRODUCTION PROCESS

Tables are crafted from carefully selected, high-quality solid wood, chosen for its durability and distinctive natural grain. Each piece of wood is precisely cut and shaped to achieve clean lines and balanced proportions. Skilled artisans meticulously assemble the components using traditional joinery techniques, ensuring lasting strength and stability. Surfaces are finely sanded to enhance the wood's texture and prepare it for finishing. The final stage involves applying a chosen finish - whether natural oil, wax, or another treatment - to protect the wood and highlight its organic beauty. The result is a versatile, handcrafted table that seamlessly blends functionality with timeless design.

PRODUCT TYPE

Table

USAGE

Indoor

DISMANTLING OPTION

No

GLIDERS

Felt pads

STOCK ITEMS

No

COUNTRY OF ORIGIN

BiH

NOTE

Mega lengths and between sizes possible. For lengths over 340 cm, a detachable **fifth leg** is required. Other modifications and prices on request.

The listed weights are approximate; the weight of each piece depends on its dimensions and the type of wood.

DIMENSIONS

Height: 76 cm/ 29.92 in

Width: 165 - 340 cm/ 64.96 - 133.86 in

Depth: 110 - 120 cm/ 43.31 - 47.24 in

Top thickness: 4 cm/ 1.57 in

Visually: : 4 cm/ 1.57 in

Leg diameter: - bottom 4x5 cm/ 1.57x1.97 in

- top 4x8 cm/ 1.57x3.15 in

PACKAGING

Stretch wrap + five-layer cardboard box.

1 piece

PACKAGING DIMENSIONS

Height: 81 cm/ 31.89 in

Width: 170 - 345cm/ 66.92 - 135.8 in

Depth: 115 - 125 cm/ 45.28 - 49.21 in

WEIGHT

Weight: 50-100 kg

Packaging: 5 - 15 kg

WOOD

Oak, American and European walnut, elm, cherry, maple, ash

TABLE TOP

Solid wood

TABLE BASE

Solid wood

WOOD FINISHES

Available in a variety of natural oil and soap finishes.

More information at artisan.ba/materials

TABLE TOP AND BASE FINISHES

Available in a variety of natural oil and soap finishes.

More information at artisan.ba/materials

CLEANING INSTRUCTIONS

Please download our material care & cleaning instructions through artisan.ba/materials

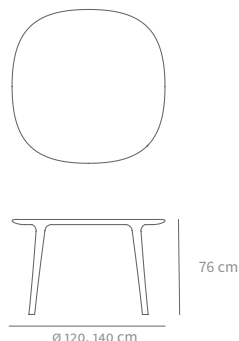

DESCRIPTION

The Luc table is a refined piece of furniture that seamlessly combines functionality with sophisticated design. Its sleek shape with a 4 cm thick tabletop offers a clean, modern aesthetic. The table is supported by uniquely designed legs, adding both visual interest and structural strength. Crafted from high-quality solid wood, the Luc oval table is available in various finishes, including Oak, European or American walnut, maple, cherry, elm and ash, each highlighting the natural beauty of the material. With its adjustable length, the table can cater to various spaces and needs, making it an ideal choice for both intimate and larger gatherings. This table exemplifies Artisan's commitment to exceptional craftsmanship and timeless design, bringing elegance and versatility to any dining area.

PRODUCTION PROCESS

Tables are crafted from carefully selected, high-quality solid wood, chosen for its durability and distinctive natural grain. Each piece of wood is precisely cut and shaped to achieve clean lines and balanced proportions. Skilled artisans meticulously assemble the components using traditional joinery techniques, ensuring lasting strength and stability. Surfaces are finely sanded to enhance the wood's texture and prepare it for finishing. The final stage involves applying a chosen finish - whether natural oil, wax, or another treatment - to protect the wood and highlight its organic beauty. The result is a versatile, handcrafted table that seamlessly blends functionality with timeless design.

PRODUCT TYPE

Table

USAGE

Indoor

DISMANTLING OPTION

No

GLIDERS

Felt pads

STOCK ITEMS

No

COUNTRY OF ORIGIN

BiH

NOTE

For diameters over 150 cm, a detachable **fifth leg** is required. Other modifications and prices on request. Other modifications and prices on request.

Seating capacity: 4 persons for both dimensions.

The listed weights are approximate; the weight of each piece depends on its dimensions and the type of wood.

DIMENSIONS

Height: 76 cm/ 29.92 in

Diameter: 120, 140/ 47.24 - 55.12 in

Top thickness: 4 cm/ 1.57 in

Visually: : 4 cm/ 1.57 in

Leg diameter: - bottom 4x5 cm/ 1.57x1.97 in

- top 4x8 cm/ 1.57x3.15 in

PACKAGING

Stretch wrap + five-layer cardboard box.

1 piece

PACKAGING DIMENSIONS

Height: 81 cm/ 31.89 in

Diameter: 125 - 145 cm/ 49.21 - 57.09 in

WEIGHT

Weight: 40-55 kg

Packaging: 3 - 7.5 kg

WOOD

Oak, American and European walnut, elm, cherry, maple, ash

TABLE TOP

Solid wood

TABLE BASE

Solid wood

WOOD FINISHES

Available in a variety of natural oil and soap finishes.

More information at artisan.ba/materials

TABLE TOP AND BASE FINISHES

Available in a variety of natural oil and soap finishes.

More information at artisan.ba/materials

CLEANING INSTRUCTIONS

Please download our material care & cleaning instructions through artisan.ba/materials

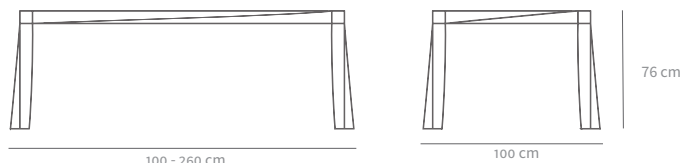

H 35, 76 W 100, 160, 180, 200, 220, 240, 260 D 100 CM

DESCRIPTION

The Torsio table gets its name from the word “torsion,” reflecting its unique design where the legs and tabletop appear as if they are twisted or “torqued” in a continuous motion. This innovative design creates a dynamic, sculptural effect that adds movement and visual interest to the piece. The base, with its angular lines and smooth curves, evokes a sense of fluidity, while the 4 cm thick tabletop rests elegantly atop, completing the bold and modern aesthetic. Designed to captivate, the Torsio table embodies both strength and grace, bringing a contemporary and artistic touch to any dining space.

PRODUCTION PROCESS

Tables are crafted from carefully selected, high-quality solid wood, chosen for its durability and distinctive natural grain. Each piece of wood is precisely cut and shaped to achieve clean lines and balanced proportions. Skilled artisans meticulously assemble the components using traditional joinery techniques, ensuring lasting strength and stability. Surfaces are finely sanded to enhance the wood’s texture and prepare it for finishing. The final stage involves applying a chosen finish - whether natural oil, wax, or another treatment - to protect the wood and highlight its organic beauty. The result is a versatile, handcrafted table that seamlessly blends functionality with timeless design.

PRODUCT TYPE

Table

USAGE

Indoor

DISMANTLING OPTION

Yes (Only on request)

GLIDERS

Felt pads

STOCK ITEMS

No

COUNTRY OF ORIGIN

BiH

NOTE

Mega lengths and between sizes possible. For lengths over 300 cm, a detachable **fifth leg** is required. Other modifications and prices on request.

The listed weights are approximate; the weight of each piece depends on its dimensions and the type of wood.

DIMENSIONS

Height: 76 cm/ 29.92 in
Width: 110 - 260 cm/ 43.31 - 102.36 in
Depth: 100 cm/ 39.37 in
Top thickness: 4 cm/ 1.57 in
Visually: 8 cm/ 3.15 in
Leg diameter: 8 cm/ 3.15 in

PACKAGING

Stretch wrap + five-layer cardboard box.
1 piece

PACKAGING DIMENSIONS

Height: 81 cm/ 31.89 in
Width: 115 - 265 cm/ 45.28 - 104.33 in
Depth: 105 cm/ 41.34 in

WEIGHT

Weight: 60 -150 kg
Packaging: 3 - 7.5 kg

WOOD

Oak, American and European walnut, elm, cherry, maple, ash

TABLE TOP

Solid wood

TABLE BASE

Solid wood

WOOD FINISHES

Available in a variety of natural oil and soap finishes.

More information at artisan.ba/materials

TABLE TOP AND BASE FINISHES

Available in a variety of natural oil and soap finishes.

More information at artisan.ba/materials

CLEANING INSTRUCTIONS

Please download our material care & cleaning instructions through artisan.ba/materials

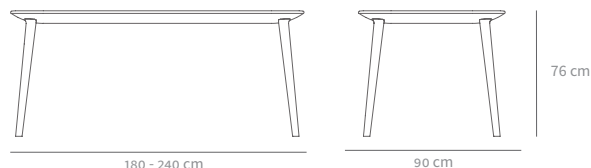

H 76 W 180, 200, 220, 240 D 90 CM

DESCRIPTION

A combination of beauty of the material, the wood basis and ceramic or leather superstructure, is bound in this collection by the common element: a calotte. A subtle association to the spherical form, to a segment of this perfect shape, is immersed in the warmth of wood, in a curved mould, like a negative embracing a body. The piece is completed by a flat surface with a contrasting tone and texture, ceramic or leather inserts, trimmed with wood, like an elegant cross-section, a calotte surface. The functional horizontal place remains visually accentuated by means of the material's aesthetic sensations, textures in seductive light and dark versions, accompanied by the imperative of the tactile, of touch.

PRODUCTION PROCESS

Tables are crafted from carefully selected, high-quality solid wood, chosen for its durability and distinctive natural grain. Each piece of wood is precisely cut and shaped to achieve clean lines and balanced proportions. Skilled artisans meticulously assemble the components using traditional joinery techniques, ensuring lasting strength and stability. Surfaces are finely sanded to enhance the wood's texture and prepare it for finishing. The final stage involves applying a chosen finish - whether natural oil, wax, or another treatment - to protect the wood and highlight its organic beauty. The result is a versatile, handcrafted table that seamlessly blends functionality with timeless design.

PRODUCT TYPE

Table

USAGE

Indoor

DISMANTLING OPTION

No

GLIDERS

Felt pads

STOCK ITEMS

No

COUNTRY OF ORIGIN

BiH

NOTE

Mega lengths and between sizes possible. For lengths over 270 cm, a detachable **fifth leg** is required. Other modifications and prices on request.

The listed weights are approximate; the weight of each piece depends on its dimensions and the type of wood.

DIMENSIONS

Height: 76 cm/ 29.92 in

Width: 180 - 240 cm/ 70.87 - 94.49 in

Depth: 90 cm/ 35.43 in

Top thickness: 8 cm/ 3.15 in

Visually: 5 cm/ 1.97 in

Leg diameter: - bottom 4x4 cm/ 1.57x1.57 in

- top 6x6 cm/ 2.36x2.36 in

PACKAGING

Stretch wrap + five-layer cardboard box.

1 piece

PACKAGING DIMENSIONS

Height: 81 cm/ 31.89 in

Width: 185 - 245 cm/ 72.83 - 96.45 in

Depth: 95 cm/ 37.40 in

WEIGHT

Weight: 55-90 kg

Packaging: 3 - 5 kg

WOOD

Oak, American and European walnut, elm, cherry, maple, ash

TABLE TOP

Solid wood or ceramic tile Fiandre in 2 colors: Sahara noir (black) and Gold Onyx maximum (white), 6 mm.

TABLE BASE

Solid wood

WOOD FINISHES

Available in a variety of natural oil and soap finishes.

More information at artisan.ba/materials

TABLE TOP AND BASE FINISHES

Available in a variety of natural oil and soap finishes.

More information at artisan.ba/materials

CLEANING INSTRUCTIONS

Please download our material care & cleaning instructions through artisan.ba/materials

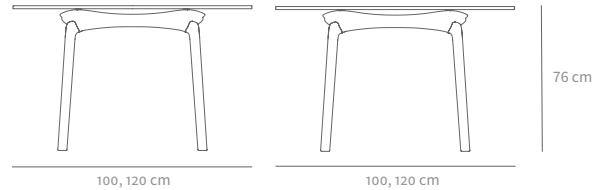

DESCRIPTION

The Pascal table is a distinguished piece that harmoniously blends natural materials with refined design. Conceived by designer Ado Avdagić, the table features a glass tabletop supported by a tripod base crafted from solid wood, available in various finishes. The glass top, with a thickness of 2 cm, rests securely on the intricately designed wooden legs, creating a visually striking contrast between the transparent surface and the rich textures of the wood. This design not only emphasizes the beauty of natural materials but also offers a versatile aesthetic that complements diverse interior styles.

PRODUCTION PROCESS

Tables are crafted from carefully selected, high-quality solid wood, chosen for its durability and distinctive natural grain. Each piece of wood is precisely cut and shaped to achieve clean lines and balanced proportions. Skilled artisans meticulously assemble the components using traditional joinery techniques, ensuring lasting strength and stability. Surfaces are finely sanded to enhance the wood's texture and prepare it for finishing. The final stage involves applying a chosen finish - whether natural oil, wax, or another treatment - to protect the wood and highlight its organic beauty. The result is a versatile, handcrafted table that seamlessly blends functionality with timeless design.

PRODUCT TYPE

Table

USAGE

Indoor

DISMANTLING OPTION

Yes

GLIDERS

Felt pads

STOCK ITEMS

No

COUNTRY OF ORIGIN

BiH

NOTE

Table top: laminated (8+8 mm thickness, in dark grey and grey option) or transparent glass (15 mm thickness).

The listed weights are approximate; the weight of each piece depends on its dimensions and the type of wood.

DIMENSIONS

Height: 76 cm/ 29.92 in

Width: 100, 120 cm/ 39.37 - 47.24 in

Depth: 100, 120 cm/ 39.37 - 47.24 in

Top thickness: 1,5 cm/ 0.59 in

Visually: 1,5 cm/ 0.59 in

Leg diameter: – bottom 4.5x4.5 cm/ 1.77x1.77 in

– top 5x5 cm/ 1.97x 1.97 in

PACKAGING

Stretch wrap + five-layer cardboard box.

1 piece

PACKAGING DIMENSIONS

Height: 81 cm/ 31.89 in

Width: 165 - 265 cm/ 64.96 - 104.33 in

Depth: 75 - 95 cm/ 29.53 - 37.40 in

WEIGHT

Weight: 50-100 kg

Packaging: 3 - 7.5 kg

WOOD

Oak, American and European walnut, elm, cherry, maple, ash

TABLE TOP

Glass

TABLE BASE

Solid wood

WOOD FINISHES

Available in a variety of natural oil and soap finishes.

More information at artisan.ba/materials

TABLE BASE FINISHES

Available in a variety of natural oil and soap finishes.

More information at artisan.ba/materials

CLEANING INSTRUCTIONS

Please download our material care & cleaning instructions through artisan.ba/materials

Pascal rectangular table

ADO AVDAGIĆ

ARTISAN®

ARTISAN.BA

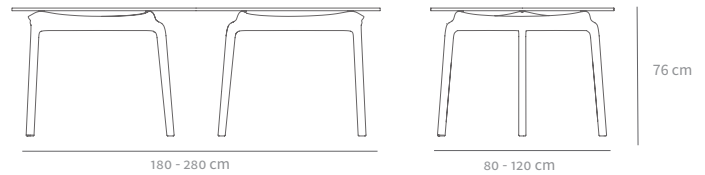

H 76
W 180, 200, 220, 240, 260, 280
D 80, 90, 100, 110, 120 CM

DESCRIPTION

The Pascal table is a distinguished piece that harmoniously blends natural materials with refined design. Conceived by designer Ado Avdagić, the table features a glass tabletop supported by a tripod base crafted from solid wood, available in various finishes. The glass top, with a thickness of 2 cm, rests securely on the intricately designed wooden legs, creating a visually striking contrast between the transparent surface and the rich textures of the wood. This design not only emphasizes the beauty of natural materials but also offers a versatile aesthetic that complements diverse interior styles.

PRODUCTION PROCESS

Tables are crafted from carefully selected, high-quality solid wood, chosen for its durability and distinctive natural grain. Each piece of wood is precisely cut and shaped to achieve clean lines and balanced proportions. Skilled artisans meticulously assemble the components using traditional joinery techniques, ensuring lasting strength and stability. Surfaces are finely sanded to enhance the wood's texture and prepare it for finishing. The final stage involves applying a chosen finish - whether natural oil, wax, or another treatment - to protect the wood and highlight its organic beauty. The result is a versatile, handcrafted table that seamlessly blends functionality with timeless design.

PRODUCT TYPE

Table

USAGE

Indoor

DISMANTLING OPTION

Yes

GLIDERS

Felt pads

STOCK ITEMS

No

COUNTRY OF ORIGIN

BiH

NOTE

Table top: laminated (8+8 mm thickness, in dark grey and grey option) or transparent glass (15 mm thickness).

The listed weights are approximate; the weight of each piece depends on its dimensions and the type of wood.

DIMENSIONS

Height: 76 cm/ 29.92 in

Width: 180, 200, 220, 240, 260, 280/ 70.87, 78.74,

86.61, 94.49, 102.36, 110.24 in

Depth: 80, 90, 100, 110, 120 cm/ 31.5, 35.43,

39.37, 43.31, 47.24 in

Top thickness: 1,5 cm/ 0.59 in

Visually: 1,5 cm/ 0.59 in

Leg diameter: – bottom 4.5x4.5 cm/ 1.77x1.77 in

– top 5x5 cm/ 1.97x 1.97 in

PACKAGING

Stretch wrap + five-layer cardboard box.

1 piece

PACKAGING DIMENSIONS

Height: 81 cm/ 31.89 in

Width: 185 - 285 cm/ 72.83 - 112.20 in

Depth: 85 - 125 cm/ 33.46 - 49.21 in

WEIGHT

Weight: 60-150 kg

Packaging: 3 - 7.5 kg

WOOD

Oak, American and European walnut, elm, cherry, maple, ash

TABLE TOP

Glass

TABLE BASE

Solid wood

WOOD FINISHES

Available in a variety of natural oil and soap finishes.

More information at artisan.ba/materials

TABLE BASE FINISHES

Available in a variety of natural oil and soap finishes.

More information at artisan.ba/materials

CLEANING INSTRUCTIONS

Please download our material care & cleaning instructions through artisan.ba/materials

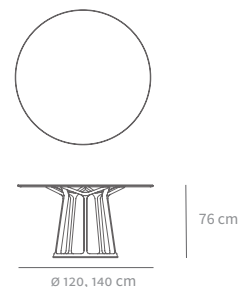

DESCRIPTION

The Pivot table, designed by Michael Schneider, embodies a harmonious blend of sculptural elegance and refined functionality. Its distinctive base and generous overhang create a striking silhouette while ensuring optimal seating comfort. Expertly crafted from premium hardwoods, Pivot is a sophisticated centerpiece that effortlessly elevates any dining environment.

PRODUCTION PROCESS

Tables are crafted from carefully selected, high-quality solid wood, chosen for its durability and distinctive natural grain. Each piece of wood is precisely cut and shaped to achieve clean lines and balanced proportions. Skilled artisans meticulously assemble the components using traditional joinery techniques, ensuring lasting strength and stability. Surfaces are finely sanded to enhance the wood's texture and prepare it for finishing. The final stage involves applying a chosen finish - whether natural oil, wax, or another treatment - to protect the wood and highlight its organic beauty. The result is a versatile, handcrafted table that seamlessly blends functionality with timeless design.

PRODUCT TYPE

Table

USAGE

Indoor

DISMANTLING OPTION

Yes

GLIDERS

Felt pads

STOCK ITEMS

No

COUNTRY OF ORIGIN

BiH

NOTE

The listed weights are approximate; the weight of each piece depends on its dimensions and the type of wood.

DIMENSIONS

Height: 76 cm/ 29.92 in
Diameter: 120, 140 cm/ 47.24, 55.12 in
Top thickness: 2 cm/ 0.79 in
Visually: 2 cm/ 0.79 in

PACKAGING

Stretch wrap + five-layer cardboard box.
1 piece

PACKAGING DIMENSIONS

Height: 81 cm/ 31.89 in
Diameter: 125 - 145 cm/ 64.96 - 104.33 in

WEIGHT

Weight: 50-80 kg
Packaging: 3 - 5 kg

WOOD

Oak, American and European walnut, elm, cherry, maple, ash

TABLE TOP

Solid wood

TABLE BASE

Solid wood

WOOD FINISHES

Available in a variety of natural oil and soap finishes.

More information at artisan.ba/materials

TABLE TOP AND BASE FINISHES

Available in a variety of natural oil and soap finishes.

More information at artisan.ba/materials

CLEANING INSTRUCTIONS

Please download our material care & cleaning instructions through artisan.ba/materials

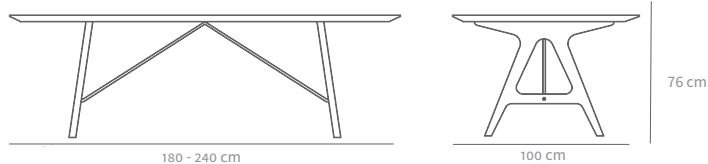

H 76 W 180, 200, 220, 240 D 100 CM

DESCRIPTION

The Tesa collection creates a functional and pleasant ambience, filled with solid wood furniture of distinctive aesthetics. Each piece contains a dose of originality, in addition to connection in details, discreetly revealing its collection-related identity. The distinctive design and superior craftsmanship of the Tesa Table, sculptural in form and curated by designer Salih Teskeredzic. Experience the tactile excellence of this uniquely crafted table, ensuring a seamless blend of aesthetic appeal and expert artisanship. A high level of refined craftsmanship is expressed in totality as much as in particular details. Tesa evokes classic quality, with a decidedly contemporary twist.

PRODUCTION PROCESS

Tables are crafted from carefully selected, high-quality solid wood, chosen for its durability and distinctive natural grain. Each piece of wood is precisely cut and shaped to achieve clean lines and balanced proportions. Skilled artisans meticulously assemble the components using traditional joinery techniques, ensuring lasting strength and stability. Surfaces are finely sanded to enhance the wood's texture and prepare it for finishing. The final stage involves applying a chosen finish - whether natural oil, wax, or another treatment - to protect the wood and highlight its organic beauty. The result is a versatile, handcrafted table that seamlessly blends functionality with timeless design.

PRODUCT TYPE

Table

USAGE

Indoor

DISMANTLING OPTION

Yes (on request)

GLIDERS

Felt pads

STOCK ITEMS

No

COUNTRY OF ORIGIN

BiH

NOTE

Mega lengths and between sizes possible. For lengths over 300 cm, a detachable **fifth leg** is required. Other modifications and prices on request.

The listed weights are approximate; the weight of each piece depends on its dimensions and the type of wood.

DIMENSIONS

Height: 76 cm/ 29.92 in

Width: 180, 200, 220, 240 cm/ 70.87, 78.74, 86.61, 94.49 in

Depth: 100 cm/ 39.37 in

Top thickness: 4 cm/ 0.79 in

Legs: Ø 1,2 cm matt grounded stainless steel in combination with wood/ 0.47 in

PACKAGING

Stretch wrap + five-layer cardboard box.

1 piece

PACKAGING DIMENSIONS

Height: 81 cm/ 31.89 in

Width: 185- 245 cm/ 72.83 in

Depth: 105 cm/ 41.34 in

WEIGHT

Weight: 62-82 kg

Packaging: 3 kg

WOOD

Oak, American and European walnut, elm, cherry, maple, ash

TABLE TOP

Solid wood

TABLE BASE

Solid wood

WOOD FINISHES

Available in a variety of natural oil and soap finishes.

More information at artisan.ba/materials

TABLE TOP AND BASE FINISHES

Available in a variety of natural oil and soap finishes.

More information at artisan.ba/materials

CLEANING INSTRUCTIONS

Please download our material care & cleaning instructions through artisan.ba/materials

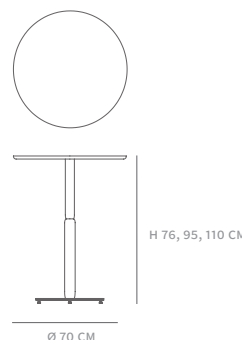

DESCRIPTION

The sophisticated Bistro table is a fresh addition to Michael Schneider's innovative designs tailored for commercial applications. Meticulously crafted with precision by Artisan, this table embodies sleekness and elegance. The Bistro table features clean lines and a minimalist aesthetic, reflecting Michael Schneider's signature style. Constructed with premium materials, it boasts a sturdy frame and a smooth tabletop, promising both durability and timeless charm. Designed for versatility, this table is ideal for various settings, from bustling cafes to upscale bistros. Available in a classic black powder coat base and a selection of premium wood species.

PRODUCTION PROCESS

Tables are crafted from carefully selected, high-quality solid wood, chosen for its durability and distinctive natural grain. Each piece of wood is precisely cut and shaped to achieve clean lines and balanced proportions. Skilled artisans meticulously assemble the components using traditional joinery techniques, ensuring lasting strength and stability. Surfaces are finely sanded to enhance the wood's texture and prepare it for finishing. The final stage involves applying a chosen finish - whether natural oil, wax, or another treatment - to protect the wood and highlight its organic beauty. The result is a versatile, handcrafted table that seamlessly blends functionality with timeless design.

PRODUCT TYPE

Table

USAGE

Indoor

DISMANTLING OPTION

Yes (on request)

GLIDERS

Adjustable feet

STOCK ITEMS

No

COUNTRY OF ORIGIN

BiH

NOTE

Other modifications and prices on request.
Table base: solid wood with powder-coated steel in RAL9005 code, 1 cm thickness with leveling metal screw with black plastic foot, height 2.2 cm. The listed weights are approximate; the weight of each piece depends on its dimensions and the type of wood.

DIMENSIONS

Height: 76, 95, 110 cm / 29.9, 37.4, 43.3 in

Diameter: 70 cm / 27.6 in

Top thickness: 2 cm / 0.79 in

Visually: 2 cm / 0.79 in

Legs: bottom 7 cm / 2.8 in

top 6 cm / 2.4 in

PACKAGING

Stretch wrap + five-layer cardboard box.

1 piece

PACKAGING DIMENSIONS

Height: 81-115 cm / 31.89 -45.28 in

Diameter: 75 cm/29.52

WEIGHT

Weight: 50-65 kg

Packaging: 3 - 5 kg

WOOD

Oak, American and European walnut, elm, cherry, maple, ash

TABLE TOP

Solid wood

TABLE BASE

Solid wood with powder-coated steel

WOOD FINISHES

Available in a variety of natural oil and soap finishes.

More information at artisan.ba/materials

TABLE TOP AND BASE FINISHES

Available in a variety of natural oil and soap finishes.

More information at artisan.ba/materials

CLEANING INSTRUCTIONS

Please download our material care & cleaning instructions through artisan.ba/materials

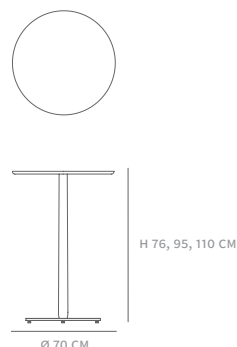

DESCRIPTION

The sophisticated Bistro table is a fresh addition to Michael Schneider's innovative designs tailored for commercial applications. Meticulously crafted with precision by Artisan, this table embodies sleekness and elegance. The Bistro Table features clean lines and a minimalist aesthetic, reflecting Michael Schneider's signature style. Constructed with premium materials, it boasts a sturdy frame and a smooth tabletop, promising both durability and timeless charm. Designed for versatility, this table is ideal for various settings, from bustling cafes to upscale bistros. Available in a classic black powder coat base and a selection of premium wood species.

PRODUCTION PROCESS

Tables are crafted from carefully selected, high-quality solid wood, chosen for its durability and distinctive natural grain. Each piece of wood is precisely cut and shaped to achieve clean lines and balanced proportions. Skilled artisans meticulously assemble the components using traditional joinery techniques, ensuring lasting strength and stability. Surfaces are finely sanded to enhance the wood's texture and prepare it for finishing. The final stage involves applying a chosen finish - whether natural oil, wax, or another treatment - to protect the wood and highlight its organic beauty. The result is a versatile, handcrafted table that seamlessly blends functionality with timeless design.

PRODUCT TYPE

Table

USAGE

Indoor

DISMANTLING OPTION

Yes

GLIDERS

Adjustable feet

STOCK ITEMS

No

COUNTRY OF ORIGIN

BiH

NOTE

Other modifications and prices on request.
Table base: solid wood with powder-coated steel in RAL9005 code, 1 cm thickness with leveling metal screw with black plastic foot, height 2.2 cm.
The listed weights are approximate; the weight of each piece depends on its dimensions and the type of wood.

DIMENSIONS

Height: 76, 95, 110 cm / 29.9, 37.4, 43.3 in

Diameter: 70 cm / 27.6 in

Top thickness: 2 cm / 0.79 in

Visually: 2 cm / 0.79 in

Legs: bottom 7 cm / 2.8 in (cone legs)
top 6 cm / 2.4 in (cone legs)

PACKAGING

Stretch wrap + five-layer cardboard box.
1 piece

PACKAGING DIMENSIONS

Height: 81 cm, 40 cm / 31.89 in, 15.75 in

Width: 165 - 265 cm / 64.96 - 104.33 in

Depth: 75 - 95 cm / 29.53 - 37.40 in

WEIGHT

Weight: 50-65 kg

Packaging: 3 - 5 kg

WOOD

Oak, American and European walnut, elm, cherry, maple, ash

TABLE TOP

Solid wood

TABLE BASE

Solid wood with powder-coated steel

WOOD FINISHES

Available in a variety of natural oil and soap finishes.

More information at artisan.ba/materials

TABLE TOP AND BASE FINISHES

Available in a variety of natural oil and soap finishes.

More information at artisan.ba/materials

CLEANING INSTRUCTIONS

Please download our material care & cleaning instructions through artisan.ba/materials

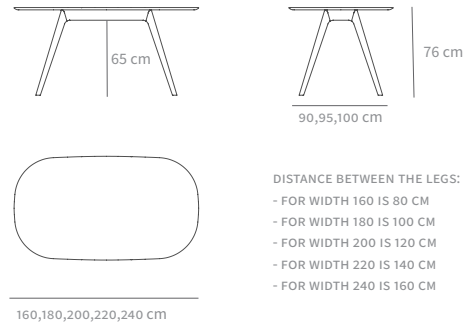

DESCRIPTION

The Coco table is a refined blend of modern design and timeless craftsmanship. With its clean lines and soft curves, this table brings both elegance and functionality to any space. Crafted from high-quality solid wood, it offers a variety of finishes to match different interior styles. The Coco table stands as a true testament to Artisan's dedication to quality and design, making it a striking yet functional addition to any room.

PRODUCTION PROCESS

Tables are crafted from carefully selected, high-quality solid wood, chosen for its durability and distinctive natural grain. Each piece of wood is precisely cut and shaped to achieve clean lines and balanced proportions. Skilled artisans meticulously assemble the components using traditional joinery techniques, ensuring lasting strength and stability. Surfaces are finely sanded to enhance the wood's texture and prepare it for finishing. The final stage involves applying a chosen finish - whether natural oil, wax, or another treatment - to protect the wood and highlight its organic beauty. The result is a versatile, handcrafted table that seamlessly blends functionality with timeless design.

PRODUCT TYPE

Table

USAGE

Indoor

DISMANTLING OPTION

Yes (only on request)

GLIDERS

Felt pads

STOCK ITEMS

No

COUNTRY OF ORIGIN

BiH

NOTE

Mega lengths and between sizes possible. For lengths over 300 cm, a detachable **fifth leg** is required. Other modifications and prices on request.
The listed weights are approximate; the weight of each piece depends on its dimensions and the type of wood.

DIMENSIONS

Height: 76 cm/ 29.92 in
Width: 160x90, 180x90, 200x95, 220x100, 240x100 cm/ 62.99x35.43, 70.86x35.43, 78.74x37.40, 86.61x39.37, 94.48x39.37in
Depth: 90,95,100 cm/ 35.43, 37.40, 39.37, in
Top thickness: 2 cm/ 0.78 in
Legs: bottom 4x4 cm/ 1.57x1.57 in
top 7.5x7.5 cm/ 2.95x2.95 in

PACKAGING

Stretch wrap + five-layer cardboard box.
1 piece

PACKAGING DIMENSIONS

Height: 81 cm/ 31.89 inin
Width: 165 - 245 cm/ 64.96 - 96.45 in
Depth: 95 cm/ 37.40 in

WEIGHT

Weight: 35-56 kg
Packaging: 2-3 kg

WOOD

Oak, American and European walnut, elm, cherry, maple, ash

TABLE TOP

Solid wood

TABLE BASE

Solid wood

WOOD FINISHES

Available in a variety of natural oil and soap finishes.
More information at artisan.ba/materials

TABLE TOP AND BASE FINISHES

Available in a variety of natural oil and soap finishes.
More information at artisan.ba/materials

CLEANING INSTRUCTIONS

Please download our material care & cleaning instructions through artisan.ba/materials

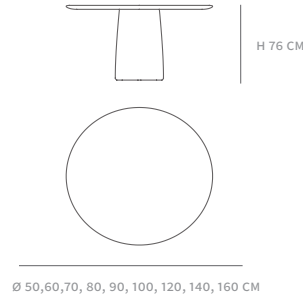

DESCRIPTION

The Column table is a statement piece with a robust yet refined form, ideal for both residential and commercial spaces. Its distinctive base transitions seamlessly from a square to a circle, creating a sculptural and dynamic presence. Handcrafted from solid wood, it highlights Artisan's dedication to timeless design and superior craftsmanship. The carefully balanced proportions enhance both aesthetics and functionality, making it a striking yet practical addition to any interior.

PRODUCTION PROCESS

Tables are crafted from carefully selected, high-quality solid wood, chosen for its durability and distinctive natural grain. Each piece of wood is precisely cut and shaped to achieve clean lines and balanced proportions. Skilled artisans meticulously assemble the components using traditional joinery techniques, ensuring lasting strength and stability. Surfaces are finely sanded to enhance the wood's texture and prepare it for finishing. The final stage involves applying a chosen finish - whether natural oil, wax, or another treatment - to protect the wood and highlight its organic beauty. The result is a versatile, handcrafted table that seamlessly blends functionality with timeless design.

PRODUCT TYPE

Table

USAGE

Indoor

DISMANTLING OPTION

Yes (only on request)

GLIDERS

Felt pads

STOCK ITEMS

No

COUNTRY OF ORIGIN

BiH

NOTE

Other modifications and prices on request.
The listed weights are approximate; the weight of each piece depends on its dimensions and the type of wood.

DIMENSIONS

Height: 76 cm/ 29.92 in

Diameter: 50, 60, 70, 80, 90, 100, 110, 120, 140, 160 cm/ 19.69, 23.62, 27.56, 31.50, 35.43, 39.37, 43.31, 47.24, 55.12, 62.99 in

Top thickness: 4 cm/ 1.57 in

PACKAGING

Stretch wrap + five-layer cardboard box.

1 piece

PACKAGING DIMENSIONS

Height: 81 cm, 40 cm/ 31.89 in, 15.75 in

Width: 165 - 265 cm/ 64.96 - 104.33 in

Depth: 75 - 95 cm/ 29.53 - 37.40 in

WEIGHT

Weight: 60-98 kg

WOOD

Oak, American and European walnut, elm, cherry, maple, ash

TABLE TOP

Solid wood

TABLE BASE

Solid wood

WOOD FINISHES

Available in a variety of natural oil and soap finishes.

More information at artisan.ba/materials

TABLE TOP AND BASE FINISHES

Available in a variety of natural oil and soap finishes.

More information at artisan.ba/materials

CLEANING INSTRUCTIONS

Please download our material care & cleaning instructions through artisan.ba/materials

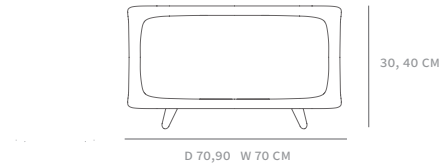

DESCRIPTION

The Blend coffee table is a masterful example of minimalist design combined with functional elegance. The table showcases clean, simple lines that make it a timeless piece for any interior. Its sophisticated design is complemented by a concealed storage compartment, allowing you to keep your living space organised while preserving the table's sleek appearance. This clever combination of style and practicality makes the Blend coffee table a perfect choice for those seeking both beauty and functionality in their furniture.

PRODUCTION PROCESS

Tables are crafted from carefully selected, high-quality solid wood, chosen for its durability and distinctive natural grain. Each piece of wood is precisely cut and shaped to achieve clean lines and balanced proportions. Skilled artisans meticulously assemble the components using traditional joinery techniques, ensuring lasting strength and stability. Surfaces are finely sanded to enhance the wood's texture and prepare it for finishing. The final stage involves applying a chosen finish - whether natural oil, wax, or another treatment - to protect the wood and highlight its organic beauty. The result is a versatile, handcrafted table that seamlessly blends functionality with timeless design.

PRODUCT TYPE

Coffee table

USAGE

Indoor

DISMANTLING OPTION

No

GLIDERS

Felt pads

STOCK ITEMS

No

COUNTRY OF ORIGIN

BiH

NOTE

Other modifications and prices on request.
The listed weights are approximate; the weight of each piece depends on its dimensions and the type of wood.

DIMENSIONS

Height: 30, 40 cm / 11.81, 15.75 in

Width: 70 cm / 27.55 in

Depth: 70, 90 cm / 27.55, 35.43 in

Top thickness: 2 cm / 0.79 in

Visually: 3 cm / 1.18 in

Leg diameter: - bottom 5x5 cm / 1.97x1.97 in

- top 5x5 cm / 1.97x 1.97 in

PACKAGING

Stretch wrap + five-layer cardboard box.

1 piece

PACKAGING DIMENSIONS

Height: 35 - 45 cm / 13.77 - 17.72 in

Width: 165 - 265 cm / 64.96 - 104.33 in

Depth: 75 - 95 cm / 29.53 - 37.40 in

WEIGHT

Weight: 24-42 kg

Packaging: 3 - 7.5 kg

WOOD

Oak, American and European walnut, elm, cherry, maple, ash

TABLE TOP

Solid wood

TABLE BASE

Solid wood

WOOD FINISHES

Available in a variety of natural oil and soap finishes.

More information at artisan.ba/materials

TABLE TOP AND BASE FINISHES

Available in a variety of natural oil and soap finishes.

More information at artisan.ba/materials

CLEANING INSTRUCTIONS

Please download our material care & cleaning instructions through artisan.ba/materials

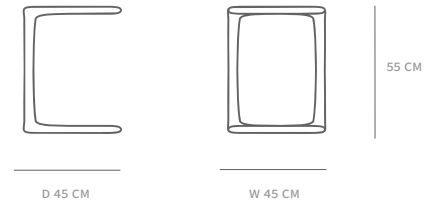

DESCRIPTION

The Blend side table is thoughtfully crafted to be highly adaptable to your space. Its minimalist design, coupled with a concealed storage compartment, allows the table to seamlessly integrate into various settings. Designed for convenience, it can be easily moved and positioned next to your sofa, providing both functionality and aesthetic appeal. This versatility makes it perfect for those who appreciate a sleek, practical piece that adapts to their lifestyle and living environment.

PRODUCTION PROCESS

Tables are crafted from carefully selected, high-quality solid wood, chosen for its durability and distinctive natural grain. Each piece of wood is precisely cut and shaped to achieve clean lines and balanced proportions. Skilled artisans meticulously assemble the components using traditional joinery techniques, ensuring lasting strength and stability. Surfaces are finely sanded to enhance the wood's texture and prepare it for finishing. The final stage involves applying a chosen finish - whether natural oil, wax, or another treatment - to protect the wood and highlight its organic beauty. The result is a versatile, handcrafted table that seamlessly blends functionality with timeless design.

PRODUCT TYPE

Side table

USAGE

Indoor

DISMANTLING OPTION

No

GLIDERS

Felt pads

STOCK ITEMS

No

COUNTRY OF ORIGIN

BiH

NOTE

Other modifications and prices on request.
The listed weights are approximate; the weight of each piece depends on its dimensions and the type of wood.

DIMENSIONS

Height: 55 cm/ in

Width: 45 cm/ in

Depth: 45 cm/ in

Top thickness: 3 cm/ in

Visually: 3 cm/ 1.18 in

Leg diameter: – bottom 5x5 cm/ 1.97x1.97 in

PACKAGING

Stretch wrap + five-layer cardboard box.

1 piece

PACKAGING DIMENSIONS

Height: 55 cm/ 21.65 in

Width: 45 cm/ 17.72 in

Depth: 45 cm/ 17.72 in

WEIGHT

Weight: 8 kg

Packaging: 2 kg

WOOD

Oak, American and European walnut, elm, cherry, maple, ash

TABLE TOP

Solid wood

TABLE BASE

Solid wood

WOOD FINISHES

Available in a variety of natural oil and soap finishes.

More information at artisan.ba/materials

TABLE TOP AND BASE FINISHES

Available in a variety of natural oil and soap finishes.

More information at artisan.ba/materials

CLEANING INSTRUCTIONS

Please download our material care & cleaning instructions through artisan.ba/materials

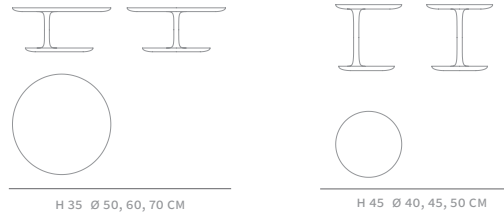

DESCRIPTION

The Bloop coffee tables are a harmonious pair, defined by symmetry with a twist. Featuring two circular wooden planes - one smooth on top, the other curved beneath - each table is connected by a vertical element. The tables vary in height and size, allowing for versatile combinations. Crafted from sustainably sourced solid wood the seamless transitions between elements evoke organic beauty and natural symmetry.

PRODUCTION PROCESS

Tables are crafted from carefully selected, high-quality solid wood, chosen for its durability and distinctive natural grain. Each piece of wood is precisely cut and shaped to achieve clean lines and balanced proportions. Skilled artisans meticulously assemble the components using traditional joinery techniques, ensuring lasting strength and stability. Surfaces are finely sanded to enhance the wood's texture and prepare it for finishing. The final stage involves applying a chosen finish - whether natural oil, wax, or another treatment - to protect the wood and highlight its organic beauty. The result is a versatile, handcrafted table that seamlessly blends functionality with timeless design.

PRODUCT TYPE

Coffee table

USAGE

Indoor

DISMANTLING OPTION

No

GLIDERS

Felt pads

STOCK ITEMS

No

COUNTRY OF ORIGIN

BiH

NOTE

Other modifications and prices on request.
The listed weights are approximate; the weight of each piece depends on its dimensions and the type of wood.

DIMENSIONS

Height: 35, 45 cm / 13.78, 17.72 in
Ø: 40, 45, 50, 60, 70 cm / 15.75, 17.72, 19.69, 23.62, 27.56 in
Top thickness: 3 cm / 1.18 in
Table Base: 38 cm / 14.96 in (for tables height 45, Ø 40, 45, 50 cm), 55 cm / 21.65 in (for tables height 35, Ø 50, 60, 70 cm)

PACKAGING

Stretch wrap + five-layer cardboard box.
1 piece

PACKAGING DIMENSIONS

Height: 40-50 cm / 15.75-19.68 in
Diameter: 45 - 75 cm / 17.72 - 29.52 in

WEIGHT

Weight: 5 - 15 kg
Packaging: 2 - 3 kg

WOOD

Oak, American and European walnut, elm, cherry, maple, ash

TABLE TOP

Solid wood

TABLE BASE

Solid wood

WOOD FINISHES

Available in a variety of natural oil and soap finishes.

More information at artisan.ba/materials

TABLE TOP AND BASE FINISHES

Available in a variety of natural oil and soap finishes.

More information at artisan.ba/materials

CLEANING INSTRUCTIONS

Please download our material care & cleaning instructions through artisan.ba/materials

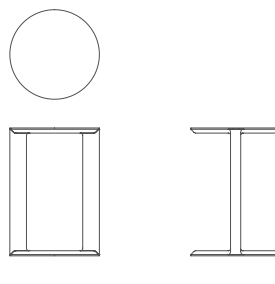
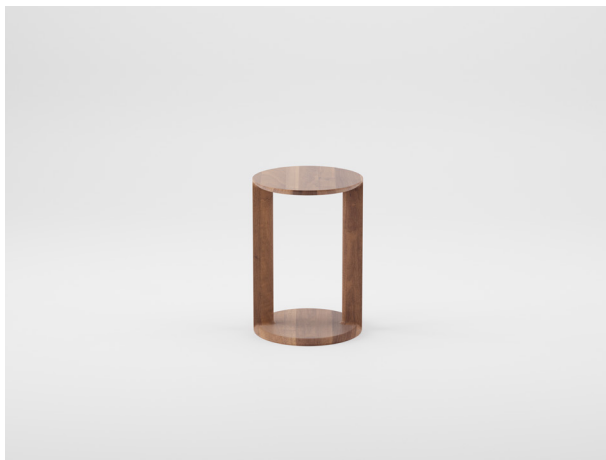

H 50 Ø 35 CM

DESCRIPTION

The Boaz side table is a testament to minimalist elegance and functional design. Crafted from solid wood, it features a circular top and base, creating a harmonious and balanced aesthetic. Its compact dimensions make it a versatile addition to various settings, easily integrating into living rooms, bedrooms, or as an accent piece in hallways. The table is available in a selection of high-quality hardwoods, including European and American walnut, oak, cherry, elm, ash, and maple, allowing for customisation to suit diverse interior styles. The Boaz side table exemplifies Artisan's commitment to quality craftsmanship and timeless design, making it a valuable addition to any home.

PRODUCTION PROCESS

Tables are crafted from carefully selected, high-quality solid wood, chosen for its durability and distinctive natural grain. Each piece of wood is precisely cut and shaped to achieve clean lines and balanced proportions. Skilled artisans meticulously assemble the components using traditional joinery techniques, ensuring lasting strength and stability. Surfaces are finely sanded to enhance the wood's texture and prepare it for finishing. The final stage involves applying a chosen finish - whether natural oil, wax, or another treatment - to protect the wood and highlight its organic beauty. The result is a versatile, handcrafted table that seamlessly blends functionality with timeless design.

PRODUCT TYPE

Coffee table

USAGE

Indoor

DISMANTLING OPTION

No

GLIDERS

Felt pads

STOCK ITEMS

No

COUNTRY OF ORIGIN

BiH

NOTE

Other modifications and prices on request.
The listed weights are approximate; the weight of each piece depends on its dimensions and the type of wood.

DIMENSIONS

Height: 35 cm / 13.78 in
Ø: 50 cm / 19.69 in
Top thickness: 2 cm / 0.78 in

PACKAGING

Stretch wrap + five-layer cardboard box.
1 piece

PACKAGING DIMENSIONS

Height: 40 cm / 15.75 in
Diameter: 55 cm / 21.65 in

WEIGHT

Weight: 4 kg
Packaging: 2 kg

WOOD

Oak, American and European walnut, elm, cherry, maple, ash

TABLE TOP

Solid wood

TABLE BASE

Solid wood

WOOD FINISHES

Available in a variety of natural oil and soap finishes.

More information at artisan.ba/materials

TABLE TOP AND BASE FINISHES

Available in a variety of natural oil and soap finishes.

More information at artisan.ba/materials

CLEANING INSTRUCTIONS

Please download our material care & cleaning instructions through artisan.ba/materials

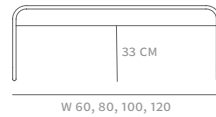

DESCRIPTION

The Eny coffee table embodies a perfect balance of contemporary design and functional elegance. Its minimalist form is accentuated by gently curved edges, giving it a soft, yet modern appeal. Crafted with attention to detail, the table seamlessly fits into various interior styles, offering both beauty and practicality. The Eny coffee table is a testament to Artisan's commitment to craftsmanship, making it a timeless and sophisticated addition to any living space.

PRODUCTION PROCESS

Tables are crafted from carefully selected, high-quality solid wood, chosen for its durability and distinctive natural grain. Each piece of wood is precisely cut and shaped to achieve clean lines and balanced proportions. Skilled artisans meticulously assemble the components using traditional joinery techniques, ensuring lasting strength and stability. Surfaces are finely sanded to enhance the wood's texture and prepare it for finishing. The final stage involves applying a chosen finish - whether natural oil, wax, or another treatment - to protect the wood and highlight its organic beauty. The result is a versatile, handcrafted table that seamlessly blends functionality with timeless design.

PRODUCT TYPE

Coffee table

USAGE

Indoor

DISMANTLING OPTION

No

GLIDERS

Felt pads

STOCK ITEMS

No

COUNTRY OF ORIGIN

BiH

NOTE

Wooden bar (10×2 cm) centered under the tabletop, full table length.
Other modifications and prices on request.
The listed weights are approximate; the weight of each piece depends on its dimensions and the type of wood.

DIMENSIONS

Height: 45 cm / 17.72 in
Width: 60, 80, 100, 120 cm / 23.62, 31.51, 39.37, 47.24 in
Depth: 60, 80, 100 cm / 23.62, 31.51, 39.37 in
Top thickness: 2 cm / 0.79 in
Visually: 2 cm / 0.79 in

PACKAGING

Stretch wrap + five-layer cardboard box.
1 piece

PACKAGING DIMENSIONS

Height: 50 cm / 19.68 in
Width: 65 - 125 cm / 25.59 - 49.21 in
Depth: 65 - 105 cm / 25.59 - 41.34 in

WEIGHT

Weight: 18-22 kg
Packaging: 2 kg

WOOD

Oak, American and European walnut, elm, cherry, maple, ash

TABLE TOP

Solid wood

TABLE BASE

Solid wood

WOOD FINISHES

Available in a variety of natural oil and soap finishes.
More information at artisan.ba/materials

TABLE TOP AND BASE FINISHES

Available in a variety of natural oil and soap finishes.
More information at artisan.ba/materials

CLEANING INSTRUCTIONS

Please download our material care & cleaning instructions through artisan.ba/materials

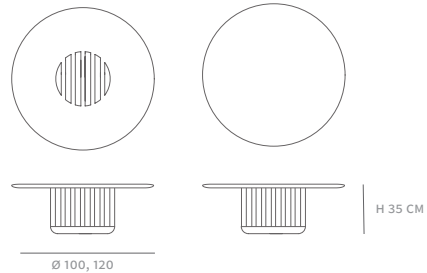

DESCRIPTION

The Grid coffee table, designed by Silva Mikelić, is a testament to minimalist elegance and functional design. Its expansive, gently rounded tabletop is supported by a robust base featuring intricate perforated details, adding a touch of sophistication to any living space. Crafted from solid wood sourced from renewable resources, the table embodies Artisan's commitment to sustainability and quality craftsmanship. An option for a solid top is available, catering to diverse aesthetic preferences. This piece seamlessly blends beauty with practicality, making it a valuable addition to contemporary.

PRODUCTION PROCESS

Tables are crafted from carefully selected, high-quality solid wood, chosen for its durability and distinctive natural grain. Each piece of wood is precisely cut and shaped to achieve clean lines and balanced proportions. Skilled artisans meticulously assemble the components using traditional joinery techniques, ensuring lasting strength and stability. Surfaces are finely sanded to enhance the wood's texture and prepare it for finishing. The final stage involves applying a chosen finish - whether natural oil, wax, or another treatment - to protect the wood and highlight its organic beauty. The result is a versatile, handcrafted table that seamlessly blends functionality with timeless design.

PRODUCT TYPE

Coffee Table

USAGE

Indoor

DISMANTLING OPTION

No

GLIDERS

Felt pads

STOCK ITEMS

No

COUNTRY OF ORIGIN

BiH

NOTE

The table is available with solid and grid table top. Mega lengths and between sizes possible. Other modifications and prices on request. The listed weights are approximate; the weight of each piece depends on its dimensions and the type of wood.

DIMENSIONS

Height: 35 cm/ 13.78 in
Diameter: 100, 120 cm/ 39.37, 47.24 in
Leg diameter: 50 (60) cm/ 19.69 (23.62) in
Top thickness: 3 cm/ 1.18 in
Visually: 3 cm/ 1.18 in

PACKAGING

Stretch wrap + five-layer cardboard box.
1 piece

PACKAGING DIMENSIONS

Height: 40 cm/ 15.75 in
Diameter : 105 - 125 cm/ 41.34 - 49.21 in

WEIGHT

Weight: 34-45 kg
Packaging: 3-3.5 kg

WOOD

Oak, American and European walnut, elm, cherry, maple, ash

TABLE TOP

Solid wood

TABLE BASE

Solid wood

WOOD FINISHES

Available in a variety of natural oil and soap finishes.

More information at artisan.ba/materials

TABLE TOP AND BASE FINISHES

Available in a variety of natural oil and soap finishes.

More information at artisan.ba/materials

CLEANING INSTRUCTIONS

Please download our material care & cleaning instructions through artisan.ba/materials

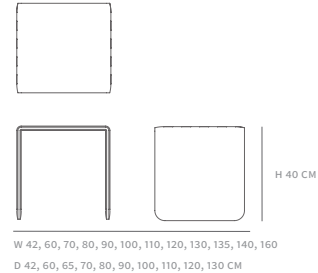

DESCRIPTION

The Invito collection is defined by robust beauty, insisting on strong forms, effected with solid and compact basic material – wood. Simple, powerful, finely proportioned forms seem reliable, evoke durability, resistance and comfort. The holders here play a clear role; built to last with exceptional stability. The beauty and strength of wood is visible in the expressive shapes of the elements, additionally accentuated by unexpected contrasts in the material, tones, colour, in the details changing and enriching the character of the piece. Invito is a collection of unassuming aesthetics, of finely crafted simple forms and of a strong character.

PRODUCTION PROCESS

Tables are crafted from carefully selected, high-quality solid wood, chosen for its durability and distinctive natural grain. Each piece of wood is precisely cut and shaped to achieve clean lines and balanced proportions. Skilled artisans meticulously assemble the components using traditional joinery techniques, ensuring lasting strength and stability. Surfaces are finely sanded to enhance the wood's texture and prepare it for finishing. The final stage involves applying a chosen finish - whether natural oil, wax, or another treatment - to protect the wood and highlight its organic beauty. The result is a versatile, handcrafted table that seamlessly blends functionality with timeless design.

PRODUCT TYPE

Coffee table

USAGE

Indoor

DISMANTLING OPTION

No

GLIDERS

Felt pads

STOCK ITEMS

No

COUNTRY OF ORIGIN

BiH

NOTE

Other modifications and prices on request.
The listed weights are approximate; the weight of each piece depends on its dimensions and the type of wood.

DIMENSIONS

Height: 40 cm/ 15.74 in
Width: 42, 60, 70, 80, 90, 100, 120, 130, 135, 140, 160 cm/ 16.54, 23.62, 27.56, 31.50, 35.43, 39.37, 47.24, 51.18, 53.15, 55.12, 62.99 in
Depth: 42, 60, 70, 80, 90, 100, 120, 130 cm/ 16.54, 23.62, 27.56, 31.50, 35.43, 39.37, 47.24, 51.18 in
Top thickness: 2 cm/ 0.79 in

PACKAGING

Stretch wrap + five-layer cardboard box.
1 piece

PACKAGING DIMENSIONS

Height: 50 cm/ 19.68 in
Width: 47 - 165 cm/ 18.50 - 64.96 in
Depth: 47 - 135 cm/ 18.50 - 53.15 in

WEIGHT

Weight: 6.5 - 28 kg
Packaging: 1-3 kg

WOOD

Oak, American and European walnut, elm, cherry, maple, ash

TABLE TOP

Solid wood

TABLE BASE

Solid wood

WOOD FINISHES

Available in a variety of natural oil and soap finishes.

More information at artisan.ba/materials

TABLE TOP AND BASE FINISHES

Available in a variety of natural oil and soap finishes.

More information at artisan.ba/materials

CLEANING INSTRUCTIONS

Please download our material care & cleaning instructions through artisan.ba/materials

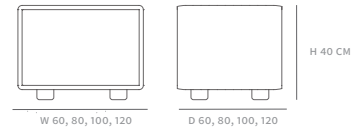

DESCRIPTION

The Invito collection is defined by robust beauty, insisting on strong forms, effected with solid and compact basic material – wood. Simple, powerful, finely proportioned forms seem reliable, evoke durability, resistance and comfort. The holders here play a clear role; built to last with exceptional stability. The beauty and strength of wood is visible in the expressive shapes of the elements, additionally accentuated by unexpected contrasts in the material, tones, colour, in the details changing and enriching the character of the piece. Invito is a collection of unassuming aesthetics, of finely crafted simple forms and of a strong character.

PRODUCTION PROCESS

Tables are crafted from carefully selected, high-quality solid wood, chosen for its durability and distinctive natural grain. Each piece of wood is precisely cut and shaped to achieve clean lines and balanced proportions. Skilled artisans meticulously assemble the components using traditional joinery techniques, ensuring lasting strength and stability. Surfaces are finely sanded to enhance the wood's texture and prepare it for finishing. The final stage involves applying a chosen finish - whether natural oil, wax, or another treatment - to protect the wood and highlight its organic beauty. The result is a versatile, handcrafted table that seamlessly blends functionality with timeless design.

PRODUCT TYPE

Coffee table

USAGE

Indoor

DISMANTLING OPTION

No

GLIDERS

Felt pads

STOCK ITEMS

No

COUNTRY OF ORIGIN

BiH

NOTE

Other modifications and prices on request.
The listed weights are approximate; the weight of each piece depends on its dimensions and the type of wood.

DIMENSIONS

Height: 40 cm/ 15.74 in
Width: 60, 80, 100, 120 cm/
Depth: 60, 80, 100, 120 cm/
16.54, 23.62, 27.56, 31.50, 35.43, 39.37, 47.24,
51.18 in
Top thickness: 2 cm/ 0.79 in

PACKAGING

Stretch wrap + five-layer cardboard box.
1 piece

PACKAGING DIMENSIONS

Height: 45 cm/ 31.89 in, 15.75 in
Width: 65 - 125 cm/ 25.59 - 49.21 in
Depth: 65 - 125 cm/ 25.59 - 49.21 in

WEIGHT

Weight: 6.5 - 28 kg
Packaging: 1-3 kg

WOOD

Oak, American and European walnut, elm,
cherry, maple, ash

TABLE TOP

Solid wood

TABLE BASE

Solid wood

WOOD FINISHES

Available in a variety of natural oil and soap finishes.

More information at artisan.ba/materials

TABLE TOP AND BASE FINISHES

Available in a variety of natural oil and soap finishes.

More information at artisan.ba/materials

CLEANING INSTRUCTIONS

Please download our material care & cleaning instructions through artisan.ba/materials

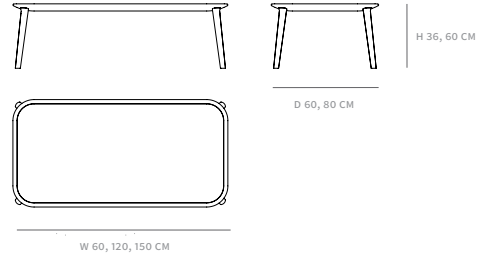

DESCRIPTION

A combination of beauty of the material, the wood basis and ceramic or leather superstructure, is bound in this collection by the common element: a calotte. A subtle association to the spherical form, to a segment of this perfect shape, is immersed in the warmth of wood, in a curved Mould, like a negative embracing a body. The piece is completed by a flat surface with a contrasting tone and texture, ceramic or leather inserts, trimmed with wood, like an elegant cross-section, a calotte surface. The functional horizontal place remains visually accentuated by means of the material's aesthetic sensations, textures in seductive light and dark versions, accompanied by the imperative of the tactile, of touch.

PRODUCTION PROCESS

Tables are crafted from carefully selected, high-quality solid wood, chosen for its durability and distinctive natural grain. Each piece of wood is precisely cut and shaped to achieve clean lines and balanced proportions. Skilled artisans meticulously assemble the components using traditional joinery techniques, ensuring lasting strength and stability. Surfaces are finely sanded to enhance the wood's texture and prepare it for finishing. The final stage involves applying a chosen finish - whether natural oil, wax, or another treatment - to protect the wood and highlight its organic beauty. The result is a versatile, handcrafted table that seamlessly blends functionality with timeless design.

PRODUCT TYPE

Coffee table

USAGE

Indoor

DISMANTLING OPTION

No

GLIDERS

Felt pads

STOCK ITEMS

No

COUNTRY OF ORIGIN

BiH

NOTE

Other modifications and prices on request.
Table base: ceramic tile Fiandre in 2 colors: Sahara noir (black) and Gold Onyx maximum (white), 6 mm.
The listed weights are approximate; the weight of each piece depends on its dimensions and the type of wood.

DIMENSIONS

Height: 36, 60 cm/ 14.17, 23.62 in
Width: 60, 120, 150 cm/ 23.62, 47.24, 59.06 in
Depth: 60, 80 cm/ 23.62, 31.50 in
Top thickness: 4 cm/ 1.57 in
Visually: 4 cm/ 1.57 in
Leg diameter:
bottom 3x4x3 cm/ 1.18x1.57x1.18 in
top 4x6x4 cm/ 1.57x2.36x1.57 in

PACKAGING

Stretch wrap + five-layer cardboard box.
1 piece

PACKAGING DIMENSIONS

Height: 40 - 65 cm/ 15.75 - 25.59 in
Width: 65 - 155 cm/ 25.59 - 61.02 in
Depth: 65 - 85 cm/ 61.02 - 33.46 in

WEIGHT

Weight: 12-27 kg
Packaging: 2-3 kg

WOOD

Oak, American and European walnut, elm, cherry, maple, ash

TABLE TOP

Solid wood or ceramic tile Fiandre in 2 colors: Sahara noir (black) and Gold Onyx maximum (white), 6 mm.

TABLE BASE

Solid wood

WOOD FINISHES

Available in a variety of natural oil and soap finishes.
More information at artisan.ba/materials

TABLE TOP AND BASE FINISHES

Available in a variety of natural oil and soap finishes.
More information at artisan.ba/materials

CLEANING INSTRUCTIONS

Please download our material care & cleaning instructions through artisan.ba/materials



DESCRIPTION

The Mars coffee table is a testament to minimalist elegance and functional design. Crafted from solid wood, it features a unique curved design that adds sophistication to any living space. A distinctive feature of the Mars coffee table is its functional storage cavity, providing practical space to keep your living area organized while maintaining a clean aesthetic. Artisan's commitment to sustainability is evident, as the table is made from FSC-certified wood, ensuring responsible sourcing and environmental friendliness. This piece exemplifies Artisan's dedication to quality craftsmanship and timeless design, making it a valuable addition to any home.

PRODUCTION PROCESS

Tables are crafted from carefully selected, high-quality solid wood, chosen for its durability and distinctive natural grain. Each piece of wood is precisely cut and shaped to achieve clean lines and balanced proportions. Skilled artisans meticulously assemble the components using traditional joinery techniques, ensuring lasting strength and stability. Surfaces are finely sanded to enhance the wood's texture and prepare it for finishing. The final stage involves applying a chosen finish — whether natural oil, wax, or another treatment - to protect the wood and highlight its organic beauty. The result is a versatile, handcrafted table that seamlessly blends functionality with timeless design.

PRODUCT TYPE

Coffee table

USAGE

Indoor

DISMANTLING OPTION

No

GLIDERS

Felt pads

STOCK ITEMS

No

COUNTRY OF ORIGIN

BiH

NOTE

Other modifications and prices on request.
The listed weights are approximate; the weight of each piece depends on its dimensions and the type of wood.

DIMENSIONS

Height: 45 cm/ 17.72 in

Width: 80, 100, 120 cm/ 31.50, 39.37, 47.24 in

Depth: 80, 100, 120 cm/ 31.50, 39.37, 47.24 in

Top thickness: 2 cm/ 0.79 in

Visually: 2 cm/ 0.79 in

PACKAGING

Stretch wrap + five-layer cardboard box.

1 piece

PACKAGING DIMENSIONS

Height: 45 cm/ 17.72 in

Width: 85 - 125 cm/ 33.46 - 49.21 in

Depth: 85 - 125 cm/ 33.46 - 49.21 in

WEIGHT

Weight: 18-28 kg

Packaging: 2-3.5 kg

WOOD

Oak, American and European walnut, elm, cherry, maple, ash

TABLE TOP

Solid wood

TABLE BASE

Solid wood

WOOD FINISHES

Available in a variety of natural oil and soap finishes.

More information at artisan.ba/materials

TABLE TOP AND BASE FINISHES

Available in a variety of natural oil and soap finishes.

More information at artisan.ba/materials

CLEANING INSTRUCTIONS

Please download our material care & cleaning instructions through artisan.ba/materials

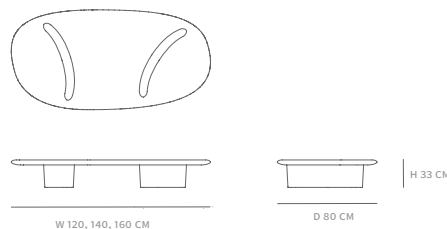

DESCRIPTION

The Monument coffee table is a striking piece that combines minimalist design with bold sculptural elements. Crafted from sustainably sourced wood, it embodies a fusion of function and art. The table's top is uniquely shaped, while the legs are angled in a way that gives it a dynamic presence, ensuring the table looks different from every angle. This exceptional design makes the Monument not just a functional piece, but a statement in any space. Its clean lines and robust structure add a timeless elegance to modern interiors. A perfect balance between simplicity and drama, the Monument coffee table serves as a testament to craftsmanship and innovative design, making it an ideal centerpiece for your living area.

PRODUCTION PROCESS

Tables are crafted from carefully selected, high-quality solid wood, chosen for its durability and distinctive natural grain. Each piece of wood is precisely cut and shaped to achieve clean lines and balanced proportions. Skilled artisans meticulously assemble the components using traditional joinery techniques, ensuring lasting strength and stability. Surfaces are finely sanded to enhance the wood's texture and prepare it for finishing. The final stage involves applying a chosen finish - whether natural oil, wax, or another treatment - to protect the wood and highlight its organic beauty. The result is a versatile, handcrafted table that seamlessly blends functionality with timeless design.

PRODUCT TYPE

Coffee table

USAGE

Indoor

DISMANTLING OPTION

Yes

GLIDERS

Felt pads

STOCK ITEMS

No

COUNTRY OF ORIGIN

BiH

NOTE

Mega lengths and between sizes possible. Other modifications and prices on request. The listed weights are approximate; the weight of each piece depends on its dimensions and the type of wood.

DIMENSIONS

Height: 33 cm/ 12.99 in

Width: 120, 140, 160 cm/ 47.24, 55.12, 62.99 in

Depth: 80 cm/ 31.50 in

Top thickness: 6 cm/ 2.36 in

Visually: 6 cm/ 2.36 in

PACKAGING

Stretch wrap + five-layer cardboard box.

1 piece

PACKAGING DIMENSIONS

Height: 40 cm/ 15.75 in

Width: 125 - 165 cm/ 49.21 - 64.96 in

Depth: 85 cm/ 33.46 in

WEIGHT

Weight: 30-100 kg

Packaging: 3 - 5 kg

WOOD

Oak, American and European walnut, elm, cherry, maple, ash

TABLE TOP

Solid wood

TABLE BASE

Solid wood

WOOD FINISHES

Available in a variety of natural oil and soap finishes.

More information at artisan.ba/materials

TABLE TOP AND BASE FINISHES

Available in a variety of natural oil and soap finishes.

More information at artisan.ba/materials

CLEANING INSTRUCTIONS

Please download our material care & cleaning instructions through artisan.ba/materials

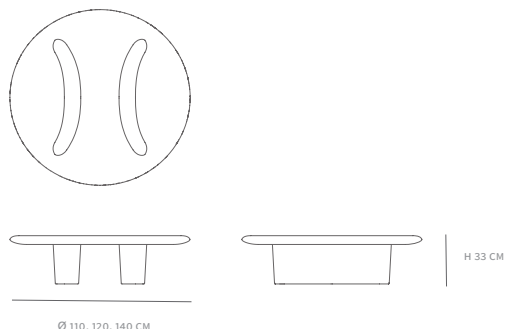

Ø 110, 120, 140 CM

H 33 CM

DESCRIPTION

The Monument coffee table is a striking piece that combines minimalist design with bold sculptural elements. Crafted from sustainably sourced wood, it embodies a fusion of function and art. The table's top is uniquely shaped, while the legs are angled in a way that gives it a dynamic presence, ensuring the table looks different from every angle. This exceptional design makes the Monument not just a functional piece, but a statement in any space. Its clean lines and robust structure add a timeless elegance to modern interiors. A perfect balance between simplicity and drama, the Monument coffee table serves as a testament to craftsmanship and innovative design, making it an ideal centerpiece for your living area.

PRODUCTION PROCESS

Tables are crafted from carefully selected, high-quality solid wood, chosen for its durability and distinctive natural grain. Each piece of wood is precisely cut and shaped to achieve clean lines and balanced proportions. Skilled artisans meticulously assemble the components using traditional joinery techniques, ensuring lasting strength and stability. Surfaces are finely sanded to enhance the wood's texture and prepare it for finishing. The final stage involves applying a chosen finish - whether natural oil, wax, or another treatment - to protect the wood and highlight its organic beauty. The result is a versatile, handcrafted table that seamlessly blends functionality with timeless design.

PRODUCT TYPE

Coffee table

USAGE

Indoor

DISMANTLING OPTION

Yes

GLIDERS

Felt pads

STOCK ITEMS

No

COUNTRY OF ORIGIN

BiH

NOTE

Mega lengths and between sizes possible. Other modifications and prices on request.

The listed weights are approximate; the weight of each piece depends on its dimensions and the type of wood.

DIMENSIONS

Height: 33 cm/ 12.99 in

Diameter: 110, 120, 140 cm/ 43.31, 47.24, 55.12 in

Top thickness: 6 cm/ 2.36 in

Visually: 6 cm/ 2.36 in

PACKAGING

Stretch wrap + five-layer cardboard box.

1 piece

PACKAGING DIMENSIONS

Height: 40 cm/ 15.75 in

Diameter: 115 - 145 cm/ 45.28 - 57.09 in

WEIGHT

Weight: 30-80 kg

Packaging: 3 - 5 kg

WOOD

Oak, American and European walnut, elm, cherry, maple, ash

TABLE TOP

Solid wood

TABLE BASE

Solid wood

WOOD FINISHES

Available in a variety of natural oil and soap finishes.

More information at artisan.ba/materials

TABLE TOP AND BASE FINISHES

Available in a variety of natural oil and soap finishes.

More information at artisan.ba/materials

CLEANING INSTRUCTIONS

Please download our material care & cleaning instructions through artisan.ba/materials

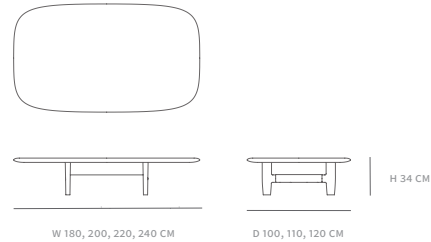

DESCRIPTION

The Nilu coffee table is inspired by traditional low Japanese tables, embracing a design philosophy that emphasizes simplicity, functionality, and a close connection to natural materials. A defining feature of the Nilu coffee table is its leather shelf, which offers a refined contrast to the solid wood construction while providing practical storage for books, magazines, or everyday essentials. Crafted with precision, the Nilu coffee table reflects Artisan's dedication to quality materials and timeless forms.

PRODUCTION PROCESS

Tables are crafted from carefully selected, high-quality solid wood, chosen for its durability and distinctive natural grain. Each piece of wood is precisely cut and shaped to achieve clean lines and balanced proportions. Skilled artisans meticulously assemble the components using traditional joinery techniques, ensuring lasting strength and stability. Surfaces are finely sanded to enhance the wood's texture and prepare it for finishing. The final stage involves applying a chosen finish - whether natural oil, wax, or another treatment - to protect the wood and highlight its organic beauty. The result is a versatile, handcrafted table that seamlessly blends functionality with timeless design.

PRODUCT TYPE

Coffee table

USAGE

Indoor

DISMANTLING OPTION

Yes (only on request)

GLIDERS

Felt pads

STOCK ITEMS

No

COUNTRY OF ORIGIN

BiH

NOTE

Shelf made in leather - Zenith collection.
Other modifications and prices on request.
The listed weights are approximate; the weight of each piece depends on its dimensions and the type of wood.

DIMENSIONS

Height: 34 cm/ 13.39 in
Width: 180, 200, 220, 240 cm/ 70.87, 78.74, 86.61, 94.49 in
Depth: 100, 110, 120 cm/ 39.37, 43.31, 47.24 in
Top thickness: 4 cm/ 1.57 in
Visually: 4 cm/ 1.57 in

PACKAGING

Stretch wrap + five-layer cardboard box.
1 piece

PACKAGING DIMENSIONS

Height: 40 cm/ 15.75 in
Width: 185 - 245 cm/ 72.83 - 96.45 in
Depth: 105 - 125 cm/ 41.34 - 49.21 in

WEIGHT

Weight: 40-80 kg
Packaging: 3 - 5 kg

WOOD

Oak, American and European walnut, elm, cherry, maple, ash

TABLE TOP

Solid wood

TABLE BASE

Solid wood

WOOD FINISHES

Available in a variety of natural oil and soap finishes.
More information at artisan.ba/materials

TABLE TOP AND BASE FINISHES

Available in a variety of natural oil and soap finishes.
More information at artisan.ba/materials

CLEANING INSTRUCTIONS

Please download our material care & cleaning instructions through artisan.ba/materials

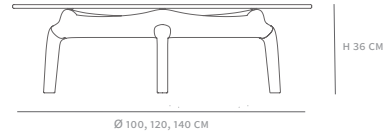

DESCRIPTION

The Pascal table is a distinguished piece that harmoniously blends natural materials with refined design. The table features a glass tabletop supported by a tripod base crafted from solid wood, available in various finishes. The glass top, with a thickness of 2 cm, rests securely on the intricately designed wooden legs, creating a visually striking contrast between the transparent surface and the rich textures of the wood. This design not only emphasizes the beauty of natural materials but also offers a versatile aesthetic that complements diverse interior styles.

PRODUCTION PROCESS

Tables are crafted from carefully selected, high-quality solid wood, chosen for its durability and distinctive natural grain. Each piece of wood is precisely cut and shaped to achieve clean lines and balanced proportions. Skilled artisans meticulously assemble the components using traditional joinery techniques, ensuring lasting strength and stability. Surfaces are finely sanded to enhance the wood's texture and prepare it for finishing. The final stage involves applying a chosen finish - whether natural oil, wax, or another treatment - to protect the wood and highlight its organic beauty. The result is a versatile, handcrafted table that seamlessly blends functionality with timeless design.

PRODUCT TYPE

Coffee table

USAGE

Indoor

DISMANTLING OPTION

Yes

GLIDERS

Felt pads

STOCK ITEMS

No

COUNTRY OF ORIGIN

BiH

NOTE

Table top: laminated (8+8 mm thickness, in dark grey and grey option) or transparent glass (15 mm thickness)

The listed weights are approximate; the weight of each piece depends on its dimensions and the type of wood.

DIMENSIONS

Height: 36 cm/ 14.17 in

Diameter: 100, 120, 140 cm/ 39.37, 47.24, 55.12 in

Top thickness: 1,5 cm/ 0.59 in

Visually: 1,5 cm/ 0.59 in

Leg diameter:

bottom 4.5x4.5 cm/ 1.77 x 1.77 in

top 5x5 cm/ 1.97 x 1.97 in

PACKAGING

Stretch wrap + five-layer cardboard box.

1 piece

PACKAGING DIMENSIONS

Height: 40 cm/ 15.75 in

Diameter: 105 - 145 cm/ 64.96 - 104.33 in

WEIGHT

Weight: 37-55 kg

Packaging: 3 - 5 kg

WOOD

Oak, American and European walnut, elm, cherry, maple, ash

TABLE TOP

Glass

TABLE BASE

Solid wood

WOOD FINISHES

Available in a variety of natural oil and soap finishes.

More information at artisan.ba/materials

TABLE BASE FINISHES

Available in a variety of natural oil and soap finishes.

More information at artisan.ba/materials

CLEANING INSTRUCTIONS

Please download our material care & cleaning instructions through artisan.ba/materials

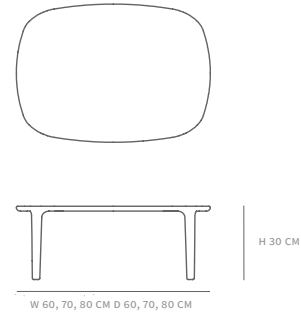

DESCRIPTION

The Wu collection is a family of solid wood furniture where the strength and warmth of the wood meet exceptionally smooth, refined design. Each piece combines timeless craftsmanship with modern elegance, creating a harmonious balance between functionality and aesthetic appeal. The intricate details of the joints between the wide seat, soft legs, and comfortable backrest make this collection both unique and original, ensuring a distinctive look that stands out in any space. These thoughtful design elements are consistently maintained and beautifully developed across the entire collection, creating a cohesive family of furniture. The Wu collection embodies both elegance and durability, offering pieces that are not only visually striking but also crafted to provide long-lasting comfort and support. Perfect for a variety of interiors, this collection exemplifies versatility, comfort, and attention to detail.

PRODUCTION PROCESS

Tables are crafted from carefully selected, high-quality solid wood, chosen for its durability and distinctive natural grain. Each piece of wood is precisely cut and shaped to achieve clean lines and balanced proportions. Skilled artisans meticulously assemble the components using traditional joinery techniques, ensuring lasting strength and stability. Surfaces are finely sanded to enhance the wood's texture and prepare it for finishing. The final stage involves applying a chosen finish - whether natural oil, wax, or another treatment - to protect the wood and highlight its organic beauty. The result is a versatile, handcrafted table that seamlessly blends functionality with timeless design.

PRODUCT TYPE

Coffee table

USAGE

Indoor

DISMANTLING OPTION

No

GLIDERS

Felt pads

STOCK ITEMS

No

COUNTRY OF ORIGIN

BiH

NOTE

Other modifications and prices on request.
The listed weights are approximate; the weight of each piece depends on its dimensions and the type of wood.

DIMENSIONS

Height: 30 cm / 11.81 in
Width: 60, 70, 80 cm / 23.62, 27.56, 31.50 in
Depth: 60, 70, 80 cm / 23.62, 27.56, 31.50 in
Top thickness: 2 cm / 0.79 in

PACKAGING

Stretch wrap + five-layer cardboard box.
1 piece

PACKAGING DIMENSIONS

Height: 35 - 45 cm / 13.77 - 15.75 in
Width: 65 - 85 cm / 25.59-33.46 in
Depth: 65 - 85 cm / 25.59-33.46 in

WEIGHT

Weight: 10 - 14kg
Packaging: 2 kg

WOOD

Oak, American and European walnut, elm, cherry, maple, ash

TABLE TOP

Solid wood

TABLE BASE

Solid wood

WOOD FINISHES

Available in a variety of natural oil and soap finishes.
More information at artisan.ba/materials

TABLE TOP AND BASE FINISHES

Available in a variety of natural oil and soap finishes.
More information at artisan.ba/materials

CLEANING INSTRUCTIONS

Please download our material care & cleaning instructions through artisan.ba/materials

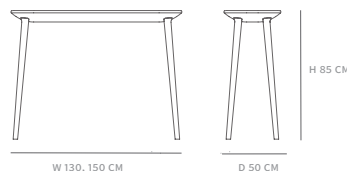

DESCRIPTION

A combination of beauty of the material, the wood basis and ceramic or leather superstructure, is bound in this collection by the common element: a calotte. The piece is completed by a flat surface with a contrasting tone and texture, ceramic or leather inserts, trimmed with wood, like an elegant cross-section, a calotte surface. The functional horizontal place remains visually accentuated by means of the material's aesthetic sensations, textures in seductive light and dark versions, accompanied by the imperative of the tactile, of touch.

PRODUCTION PROCESS

Tables are crafted from carefully selected, high-quality solid wood, chosen for its durability and distinctive natural grain. Each piece of wood is precisely cut and shaped to achieve clean lines and balanced proportions. Skilled artisans meticulously assemble the components using traditional joinery techniques, ensuring lasting strength and stability. Surfaces are finely sanded to enhance the wood's texture and prepare it for finishing. The final stage involves applying a chosen finish - whether natural oil, wax, or another treatment - to protect the wood and highlight its organic beauty. The result is a versatile, handcrafted table that seamlessly blends functionality with timeless design.

PRODUCT TYPE

Console table

USAGE

Indoor

DISMANTLING OPTION

No

GLIDERS

Felt pads

STOCK ITEMS

No

COUNTRY OF ORIGIN

BiH

NOTE

Other modifications and prices on request.
Table base: ceramic tile Fiandre in 2 colors: Sahara noir (black) and Gold Onyx maximum (white), 6 mm.
The listed weights are approximate; the weight of each piece depends on its dimensions and the type of wood.

DIMENSIONS

Height: 85 cm/ 33.46 in
Width: 130, 150 cm/ 51.18, 59.06 in
Depth: 50 cm/ 19.69 in
Top thickness: 8 cm/ 3.15 in
Visually: 8 cm/ 3.15 in
Leg diameter:
bottom 4x6x4 cm/ 1.57 x 2.36 x 1.57 in
top 6x8x6 cm/ 2.36 x 3.15 x 2.36 in

PACKAGING

Stretch wrap + five-layer cardboard box.
1 piece

PACKAGING DIMENSIONS

Height: 90 cm/ 35.43 in
Width: 135-155 cm/ 53.15 - 61.02 in
Depth: 55 cm/ 21.65 in

WEIGHT

Weight: 12-27 kg
Packaging: 2-3 kg

WOOD

Oak, American and European walnut, elm, cherry, maple, ash

TABLE TOP

Solid wood or ceramic tile Fiandre in 2 colors: Sahara noir (black) and Gold Onyx maximum (white), 6 mm

TABLE BASE

Solid wood

WOOD FINISHES

Available in a variety of natural oil and soap finishes.
More information at artisan.ba/materials

TABLE TOP AND BASE FINISHES

Available in a variety of natural oil and soap finishes.
More information at artisan.ba/materials

CLEANING INSTRUCTIONS

Please download our material care & cleaning instructions through artisan.ba/materials

Lasta console table

ADO AVDAGIĆ

ARTISAN[®]
ARTISAN.BA

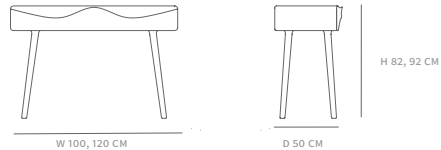

DESCRIPTION

The Lasta console table is part of a collection that exudes strength, durability, and timeless elegance. Named after the swallow (“Lasta” in Bosnian), the design captures the bird’s graceful essence, symbolizing lightness and movement. The console’s standout feature is its distinctive wooden fronts, where precisely shaped grooves form a flowing pattern that resembles a swallow’s wings in flight. These sculpted lines add depth and texture, emphasising the natural beauty of the wood and creating a dynamic interplay of light and shadow. With its solid construction and rich, organic character, the Lasta console table seamlessly blends functionality and artistry, making it a striking addition to any space. Like the rest of the Lasta collection, it’s a testament to thoughtful design and enduring craftsmanship.

PRODUCTION PROCESS

Tables are crafted from carefully selected, high-quality solid wood, chosen for its durability and distinctive natural grain. Each piece of wood is precisely cut and shaped to achieve clean lines and balanced proportions. Skilled artisans meticulously assemble the components using traditional joinery techniques, ensuring lasting strength and stability. Surfaces are finely sanded to enhance the wood’s texture and prepare it for finishing. The final stage involves applying a chosen finish - whether natural oil, wax, or another treatment - to protect the wood and highlight its organic beauty. The result is a versatile, handcrafted table that seamlessly blends functionality with timeless design.

PRODUCT TYPE

Console table

USAGE

Indoor

DISMANTLING OPTION

No

GLIDERS

Felt pads

STOCK ITEMS

No

COUNTRY OF ORIGIN

BiH

NOTE

Other modifications and prices on request.
The listed weights are approximate; the weight of each piece depends on its dimensions and the type of wood.

DIMENSIONS

Height: 82, 92 cm/ 32.28, 36.22 in
Width: 100, 120 cm/ 39.37, 47.24 in
Depth: 50 cm/ 19.69 in
Commode thickness: 2 cm/ 0.79 in
Foreparts thickness: 5 cm/ 1.97 in
Leg diameter:
bottom 3x3 cm/ 1.18 x 1.18 in
top 4x4 cm/ 1.57 x 1.57 in
Drawers: 1 piece

PACKAGING

Stretch wrap + five-layer cardboard box.
1 piece

PACKAGING DIMENSIONS

Height: 90 - 100 cm/ 35.43 - 39.37 in
Width: 105 - 125 cm/ 41.34 - 49.21 in
Depth: 55 cm/ 21.65 in

WEIGHT

Weight: 32 - 47 kg
Packaging: 3 kg

WOOD

Oak, American and European walnut, elm, cherry, maple, ash

TABLE TOP

Solid wood

TABLE BASE

Solid wood

WOOD FINISHES

Available in a variety of natural oil and soap finishes.
More information at artisan.ba/materials

TABLE TOP AND BASE FINISHES

Available in a variety of natural oil and soap finishes.
More information at artisan.ba/materials

CLEANING INSTRUCTIONS

Please download our material care & cleaning instructions through artisan.ba/materials

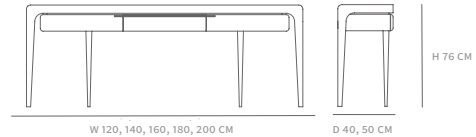

DESCRIPTION

The Latus console, a testament to the fusion of strength, nature, and the poetic essence of timber as a material. The beautiful Latus collection embodies emotion, form, honesty, and a logical approach to timber, enhanced by the innovative high-tech technology curated by Artisan. Available in seven distinct wood types - Oak, European walnut, American walnut, maple, elm, cherry, and ash. Choose from a spectrum of natural finishes, oils, and soap options, with the added feature of two and three-drawer configurations.

PRODUCTION PROCESS

Tables are crafted from carefully selected, high-quality solid wood, chosen for its durability and distinctive natural grain. Each piece of wood is precisely cut and shaped to achieve clean lines and balanced proportions. Skilled artisans meticulously assemble the components using traditional joinery techniques, ensuring lasting strength and stability. Surfaces are finely sanded to enhance the wood's texture and prepare it for finishing. The final stage involves applying a chosen finish - whether natural oil, wax, or another treatment - to protect the wood and highlight its organic beauty. The result is a versatile, handcrafted table that seamlessly blends functionality with timeless design.

PRODUCT TYPE

Console table

USAGE

Indoor

DISMANTLING OPTION

No

GLIDERS

Felt pads

STOCK ITEMS

No

COUNTRY OF ORIGIN

BiH

NOTE

Other modifications and prices on request.
The listed weights are approximate; the weight of each piece depends on its dimensions and the type of wood.

DIMENSIONS

Height: 76 cm / 29.92 in
Width: 120, 140, 160, 180, 200 cm / 47.24, 55.12, 62.99, 70.87, 78.74 in
Depth: 40, 50 cm / 15.75, 19.69 in
Top thickness: 4 cm / 1.57 in
Visually: 6 cm / 2.36 in
Leg diameter:
bottom Ø3 cm / 1.18 in
top Ø6 cm / 2.36 in
Drawers: 3 pieces for 160, 180, 200 cm;
2 pieces for 120 and 140 cm

PACKAGING

Stretch wrap + five-layer cardboard box.
1 piece

PACKAGING DIMENSIONS

Height: 81 cm / 31.89 in
Width: 125 - 205 cm / 64.96 - 104.33 in
Depth: 45-55 cm / 29.53 - 37.40 in

WEIGHT

Weight: 36-70 kg
Packaging: 3 - 5 kg

WOOD

Oak, American and European walnut, elm, cherry, maple, ash

TABLE TOP

Solid wood

TABLE BASE

Solid wood

WOOD FINISHES

Available in a variety of natural oil and soap finishes.

More information at artisan.ba/materials

TABLE TOP AND BASE FINISHES

Available in a variety of natural oil and soap finishes.

More information at artisan.ba/materials

CLEANING INSTRUCTIONS

Please download our material care & cleaning instructions through artisan.ba/materials

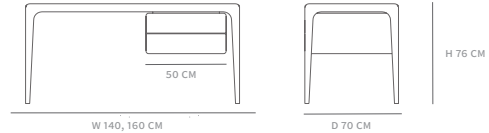

DESCRIPTION

Tranquil lines of fine craftsmanship highlight the beauty of the material and evoke a continuous flow by masterfully soft transitions, creating a functional yet sculptural quality. The result is exceptionally pure forms, revealing the flexibility and beauty of a solid material. The beauty of design is additionally accentuated by the understanding of the raw material, by respecting and visually underlining the structure of wood, creating a unique quality of aesthetics and an elegant structure.

PRODUCTION PROCESS

Tables are crafted from carefully selected, high-quality solid wood, chosen for its durability and distinctive natural grain. Each piece of wood is precisely cut and shaped to achieve clean lines and balanced proportions. Skilled artisans meticulously assemble the components using traditional joinery techniques, ensuring lasting strength and stability. Surfaces are finely sanded to enhance the wood's texture and prepare it for finishing. The final stage involves applying a chosen finish - whether natural oil, wax, or another treatment - to protect the wood and highlight its organic beauty. The result is a versatile, handcrafted table that seamlessly blends functionality with timeless design.

PRODUCT TYPE

Desk

USAGE

Indoor

DISMANTLING OPTION

Yes (on request)

GLIDERS

Felt pads

STOCK ITEMS

No

COUNTRY OF ORIGIN

BiH

NOTE

Other modifications and prices on request.
Standard desk top: solid wood
The listed weights are approximate; the weight of each piece depends on its dimensions and the type of wood.

DIMENSIONS

Height: 76 cm / 29.92 in
Width: 140, 160 cm / 55.12, 62.99 in
Depth: 70 cm / 27.56 in
Top thickness: 4 cm / 1.57 in
Visually: 6 cm / 2.36 in
Leg diameter:
bottom Ø3 cm / 1.18 in
top Ø6 cm / 2.36 in
Drawers: 2 pieces

PACKAGING

Stretch wrap + five-layer cardboard box.
1 piece

PACKAGING DIMENSIONS

Height: 81 cm / 31.89 in
Width: 145 - 165 cm / 57.09 - 64.96 in
Depth: 75 cm / 29.52 in

WEIGHT

Weight: 60 - 75 kg
Packaging: 3 kg

WOOD

Oak, American and European walnut, elm, cherry, maple, ash

TABLE TOP

Solid wood

TABLE BASE

Solid wood

WOOD FINISHES

Available in a variety of natural oil and soap finishes.
More information at artisan.ba/materials

TABLE TOP AND BASE FINISHES

Available in a variety of natural oil and soap finishes.
More information at artisan.ba/materials

CLEANING INSTRUCTIONS

Please download our material care & cleaning instructions through artisan.ba/materials

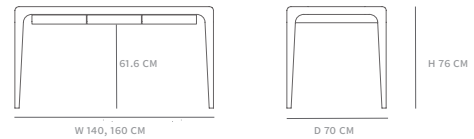

DESCRIPTION

Tranquil lines of fine craftsmanship highlight the beauty of the material and evoke a continuous flow by masterfully soft transitions, creating a functional yet sculptural quality. The result is exceptionally pure forms, revealing the flexibility and beauty of a solid material. The beauty of design is additionally accentuated by the understanding of the raw material, by respecting and visually underlining the structure of wood, creating a unique quality of aesthetics and an elegant structure.

PRODUCTION PROCESS

Tables are crafted from carefully selected, high-quality solid wood, chosen for its durability and distinctive natural grain. Each piece of wood is precisely cut and shaped to achieve clean lines and balanced proportions. Skilled artisans meticulously assemble the components using traditional joinery techniques, ensuring lasting strength and stability. Surfaces are finely sanded to enhance the wood's texture and prepare it for finishing. The final stage involves applying a chosen finish - whether natural oil, wax, or another treatment - to protect the wood and highlight its organic beauty. The result is a versatile, handcrafted table that seamlessly blends functionality with timeless design.

PRODUCT TYPE

Desk

USAGE

Indoor

DISMANTLING OPTION

Yes (on request)

GLIDERS

Felt pads

STOCK ITEMS

No

COUNTRY OF ORIGIN

BiH

NOTE

Other modifications and prices on request.
Standard desk top: solid wood
The listed weights are approximate; the weight of each piece depends on its dimensions and the type of wood.

DIMENSIONS

Height: 76 cm/ 29.92 in
Width: 140, 160 cm/ 55.12, 62.99 in
Depth: 70 cm/ 27.56 in
Top thickness: 4 cm/ 1.57 in
Visually: 6 cm/ 2.36 in
Leg diameter:
bottom Ø3 cm/ 1.18 in
top Ø6 cm/ 2.36 in
Drawers: 3 pieces

PACKAGING

Stretch wrap + five-layer cardboard box.
1 piece

PACKAGING DIMENSIONS

Height: 81 cm/ 31.89 in
Width: 145 - 165 cm/ 57.09 - 64.96 in
Depth: 75 cm/ 29.53 in

WEIGHT

Weight: 57 - 65 kg
Packaging: 3 kg

WOOD

Oak, American and European walnut, elm, cherry, maple, ash

TABLE TOP

Solid wood

TABLE BASE

Solid wood

WOOD FINISHES

Available in a variety of natural oil and soap finishes.
More information at artisan.ba/materials

TABLE TOP AND BASE FINISHES

Available in a variety of natural oil and soap finishes.
More information at artisan.ba/materials

CLEANING INSTRUCTIONS

Please download our material care & cleaning instructions through artisan.ba/materials

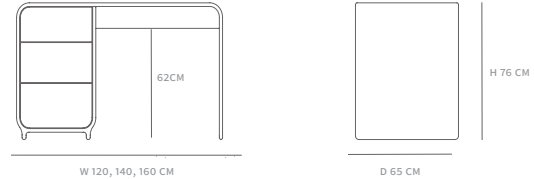

DESCRIPTION

The Eny desk embodies a perfect balance of contemporary design and functional elegance. Its minimalist form is accentuated by gently curved edges, giving it a soft, yet modern appeal. Crafted with attention to detail, the table seamlessly fits into various interior styles, offering both beauty and practicality. The Eny desk is a testament to Artisan's commitment to craftsmanship, making it a timeless and sophisticated addition to any living space.

PRODUCTION PROCESS

Tables are crafted from carefully selected, high-quality solid wood, chosen for its durability and distinctive natural grain. Each piece of wood is precisely cut and shaped to achieve clean lines and balanced proportions. Skilled artisans meticulously assemble the components using traditional joinery techniques, ensuring lasting strength and stability. Surfaces are finely sanded to enhance the wood's texture and prepare it for finishing. The final stage involves applying a chosen finish - whether natural oil, wax, or another treatment - to protect the wood and highlight its organic beauty. The result is a versatile, handcrafted table that seamlessly blends functionality with timeless design.

PRODUCT TYPE

Desk

USAGE

Indoor

DISMANTLING OPTION

No

GLIDERS

Felt pads

STOCK ITEMS

No

COUNTRY OF ORIGIN

BiH

NOTE

Wooden bar (12x2 cm) centered under the tabletop, running up to the drawer.
Other modifications and prices on request.
The listed weights are approximate; the weight of each piece depends on its dimensions and the type of wood.

DIMENSIONS

Height: 76 cm / 29.92 in
Width: 120, 140, 160 cm / 47.24, 55.12, 62.99 in
Depth: 65 cm / 25.59 in
Top thickness: 2 cm / 0.79 in
Visually: 2 cm / 0.79 in
Drawers: 3 pieces - push to open

PACKAGING

Stretch wrap + five-layer cardboard box.
1 piece

PACKAGING DIMENSIONS

Height: 81 cm / 31.89 in
Width: 125 - 165 cm / 49.21 - 64.96 in
Depth: 70 cm / 27.55 in

WEIGHT

Weight: 67-72 kg
Packaging: 3 - 3.5 kg

WOOD

Oak, American and European walnut, elm, cherry, maple, ash

TABLE TOP

Solid wood

TABLE BASE

Solid wood

WOOD FINISHES

Available in a variety of natural oil and soap finishes.
More information at artisan.ba/materials

TABLE TOP AND BASE FINISHES

Available in a variety of natural oil and soap finishes.
More information at artisan.ba/materials

CLEANING INSTRUCTIONS

Please download our material care & cleaning instructions through artisan.ba/materials

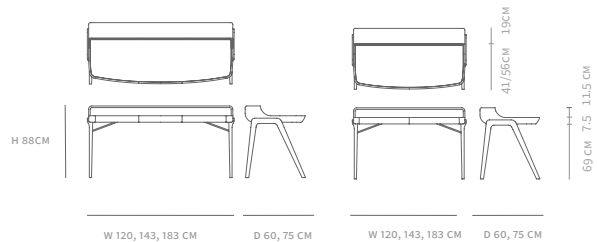

DESCRIPTION

The wooden surface area creates an organised and pleasant workspace; it envelops a space, conceals elegant drawers, and extends into an ample workspace. The piece is completed and arched by a simple and practical shelf, a horizontal element that creates added value and organisational potential. The compact legs are attached to the lateral sides of the table, leaving the workspace free; both strong and elegant, they are additionally fixed by metal holders. Its design creates a plausible body, elegant and powerful, a comfortable workspace suited to both more intimate and dynamic ambiances.

PRODUCTION PROCESS

Tables are crafted from carefully selected, high-quality solid wood, chosen for its durability and distinctive natural grain. Each piece of wood is precisely cut and shaped to achieve clean lines and balanced proportions. Skilled artisans meticulously assemble the components using traditional joinery techniques, ensuring lasting strength and stability. Surfaces are finely sanded to enhance the wood's texture and prepare it for finishing. The final stage involves applying a chosen finish - whether natural oil, wax, or another treatment - to protect the wood and highlight its organic beauty. The result is a versatile, handcrafted table that seamlessly blends functionality with timeless design.

PRODUCT TYPE

Desk

USAGE

Indoor

DISMANTLING OPTION

Yes

GLIDERS

Felt pads

STOCK ITEMS

No

COUNTRY OF ORIGIN

BiH

NOTE

Other modifications and prices on request.
120 and 143 desks are with 2 drawers, 183 is with 3 drawers.
The listed weights are approximate; the weight of each piece depends on its dimensions and the type of wood.

DIMENSIONS

Height: 88 cm/ 34.65 in
Width: 120, 143, 183 cm/ 47.24, 56.30, 72.05 in
Depth: 60, 75 cm/ 23.62, 29.53 in
Drawers: 2/3 pieces

Standard desk top: solid wood
Additional top options: solid wood painted, Corian
Metal parts: black painted (other color on request)

PACKAGING

Stretch wrap + five-layer cardboard box.
1 piece

PACKAGING DIMENSIONS

Height: 81 cm, 90 cm/ 31.89 in, 35.43 in
Width: 125 - 190 cm/ 49.21 - 74.80 in
Depth: 65 - 80 cm/ 25.59 - 33.46 in

WEIGHT

Weight: 30 - 50 kg
Packaging: 3 kg

WOOD

Oak, American and European walnut, elm, cherry, maple, ash

TABLE TOP

Solid wood

TABLE BASE

Solid wood

WOOD FINISHES

Available in a variety of natural oil and soap finishes.

More information at artisan.ba/materials

TABLE TOP AND BASE FINISHES

Available in a variety of natural oil and soap finishes.

More information at artisan.ba/materials

CLEANING INSTRUCTIONS

Please download our material care & cleaning instructions through artisan.ba/materials

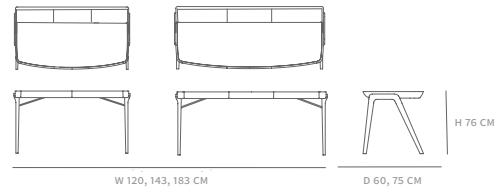

DESCRIPTION

The wooden surface area creates an organised and pleasant workspace; it envelops a space, conceals elegant drawers, and extends into an ample workspace. The piece is completed and arched by a simple and practical shelf, a horizontal element that creates added value and organisational potential. The compact legs are attached to the lateral sides of the table, leaving the workspace free; both strong and elegant, they are additionally fixed by metal holders. Its design creates a plausible body, elegant and powerful, a comfortable workspace suited to both more intimate and dynamic ambiances.

PRODUCTION PROCESS

Tables are crafted from carefully selected, high-quality solid wood, chosen for its durability and distinctive natural grain. Each piece of wood is precisely cut and shaped to achieve clean lines and balanced proportions. Skilled artisans meticulously assemble the components using traditional joinery techniques, ensuring lasting strength and stability. Surfaces are finely sanded to enhance the wood's texture and prepare it for finishing. The final stage involves applying a chosen finish - whether natural oil, wax, or another treatment - to protect the wood and highlight its organic beauty. The result is a versatile, handcrafted table that seamlessly blends functionality with timeless design.

PRODUCT TYPE

Desk

USAGE

Indoor

DISMANTLING OPTION

Yes

GLIDERS

Felt pads

STOCK ITEMS

No

COUNTRY OF ORIGIN

BiH

NOTE

Other modifications and prices on request.
120 and 143 desks are with 2 drawers, 183 is with 3 drawers.
The listed weights are approximate; the weight of each piece depends on its dimensions and the type of wood.

DIMENSIONS

Height: 76cm/ 29.92 in
Width: 120, 143, 183 cm/ 47.24, 56.30, 72.05 in
Depth: 60, 75 cm/ 23.62, 29.53 in
Drawers: 2/3 pieces
Standard desk top: solid wood
Additional top options: solid wood painted, Corian
Metal parts: black painted (other color on request)

PACKAGING

Stretch wrap + five-layer cardboard box.
1 piece

PACKAGING DIMENSIONS

Height: 81 cm, 90 cm/ 31.89 in, 35.43 in
Width: 125 - 190 cm/ 49.21 - 74.80 in
Depth: 65 - 80 cm/ 25.59 - 33.46 in

WEIGHT

Weight: 30 - 50 kg
Packaging: 3 kg

WOOD

Oak, American and European walnut, elm, cherry, maple, ash

TABLE TOP

Solid wood

TABLE BASE

Solid wood

WOOD FINISHES

Available in a variety of natural oil and soap finishes.
More information at artisan.ba/materials

TABLE TOP AND BASE FINISHES

Available in a variety of natural oil and soap finishes.
More information at artisan.ba/materials

CLEANING INSTRUCTIONS

Please download our material care & cleaning instructions through artisan.ba/materials

AMERICAN WALNUT
A01 Natural soap



AMERICAN WALNUT
A03 Natural oil



EUROPEAN WALNUT
A01 Natural soap



EUROPEAN WALNUT
A03 Natural oil



EUROPEAN WALNUT
A04 White oil



EUROPEAN WALNUT WITH KNOTS
A03 Natural oil



OAK
A01 Natural soap



OAK
A03 Natural oil



OAK
A3 Loba white oil



OAK
A04 White pigmented oil



OAK
Wenge oil

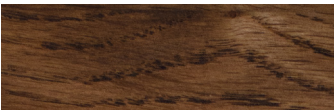

OAK
AR1 Jahorina pigment



OAK
Rubio black



OAK WITH KNOTS
A03 Natural oil



ELM
A01 Natural soap



ELM
A03 Natural oil



ELM
A04 White pigmented oil



ELM
AR1 Jahorina pigment



CHERRY
A01 Natural soap

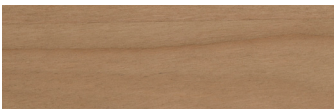

CHERRY
A03 Natural oil



CHERRY
AR4 Dark oil

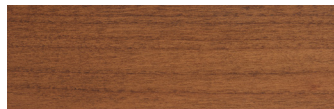

MAPLE
A01 Natural soap



MAPLE
A04 White pigmented oil



ASH
A04 White pigmented oil



AVAILABLE IN COLORED WOOD.

For more material options please check artisan.ba/materials