

NORDIC



VILMERS

NORDIC



Removable cover



Loose cushions

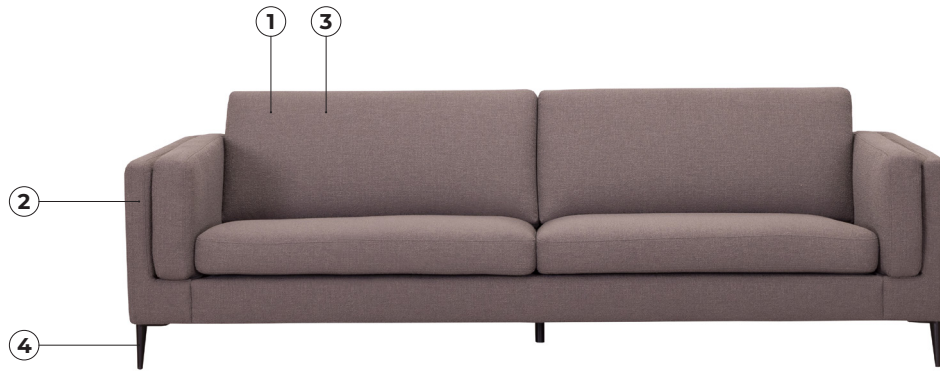

Comfort

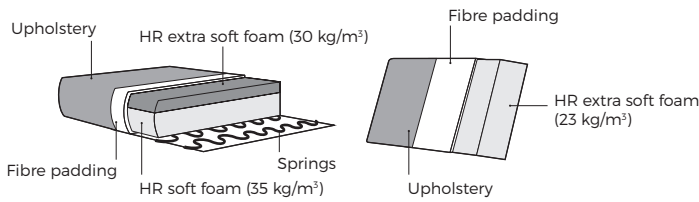

1. Upholstery



Leather*

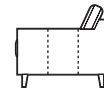

Fabric

* Leather upholstery may require more stitches than fabric upholstery.

2. Armrests



STYLE W 9 x D 90 x H 53 **SLIM** W 9 x D 90 x H 53 **FANCY** W 11 x D 90 x H 53 **LESS** W 12 x D 90 x H 48 **POLO** W 13 x D 90 x H 53 **SHARE** W 16 x D 90 x H 48 **DUO** W 20 x D 90 x H 53 **EVO** W 20 x D 90 x H 49 **OMEGA*** W 3 x D 90 x H 53

*Not suitable for Chaise Longue

3. Multicolour option



4. Legs



385 Black metal

387 Black metal

191 White oiled

257 White oiled

529 White oiled

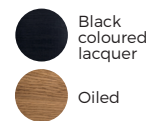

256 Metal

444 Black metal

IMPORTANT:

Upholstered furniture is handmade using soft materials, therefore measurements can vary in all modules by up to **+/-2 cm**.
 Modules and combinations shown in 2D drawings are left-sided. Modules and combinations can be mirrored from left to right.
 For an additional fee, the sides of each seater module can be covered in fabric.

Modules (Measurements with SHARE armrest)

Scale 1:100

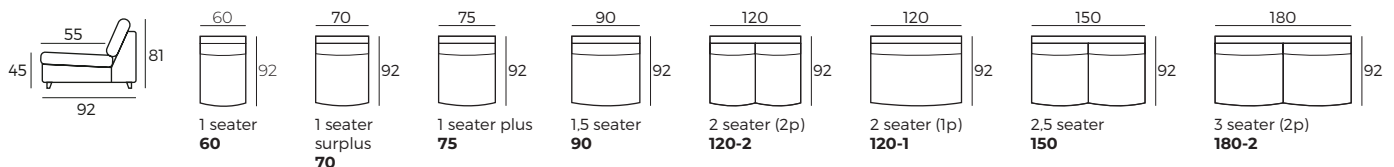

NORDIC

Modules (Measurements with SHARE armrest)

Scale 1:100

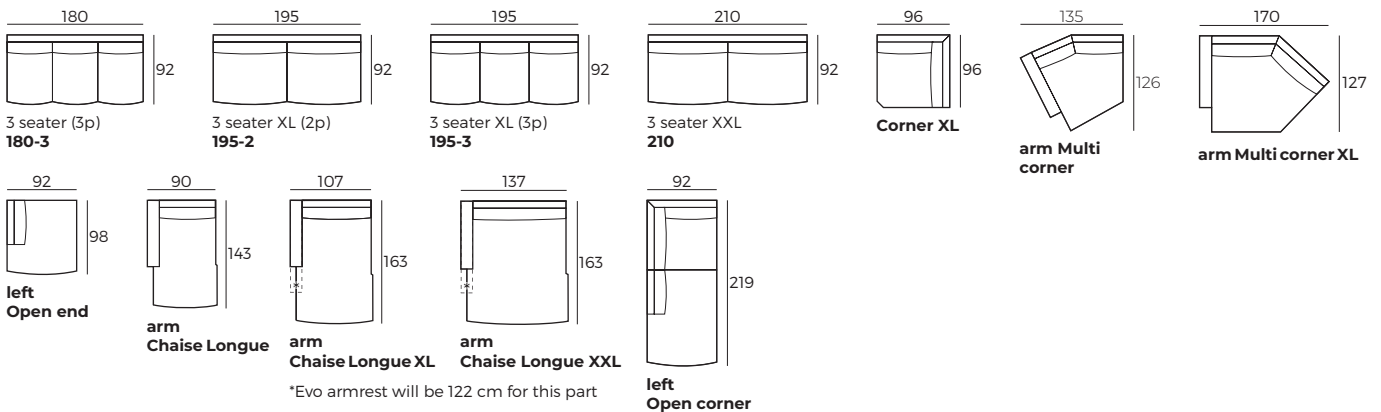

Modules with armrest (Measurements with SHARE armrest)

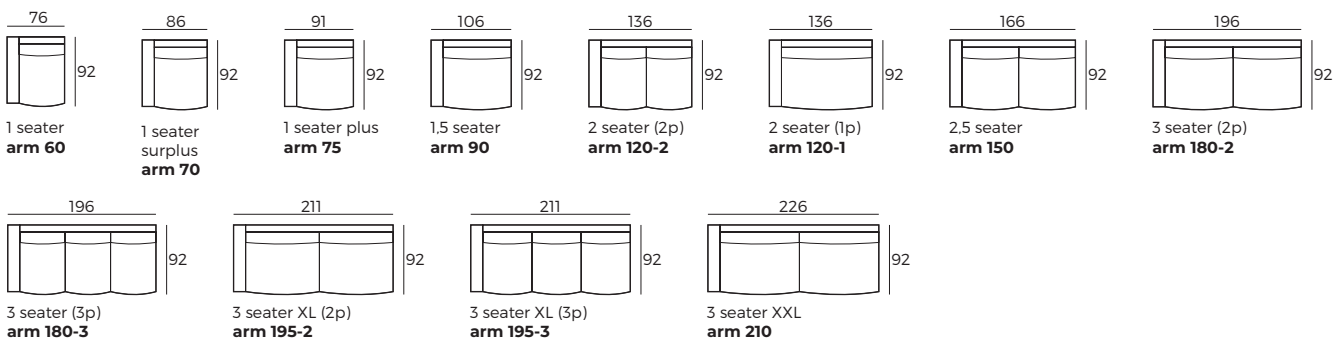

Combinations (Measurements with SHARE armrest)

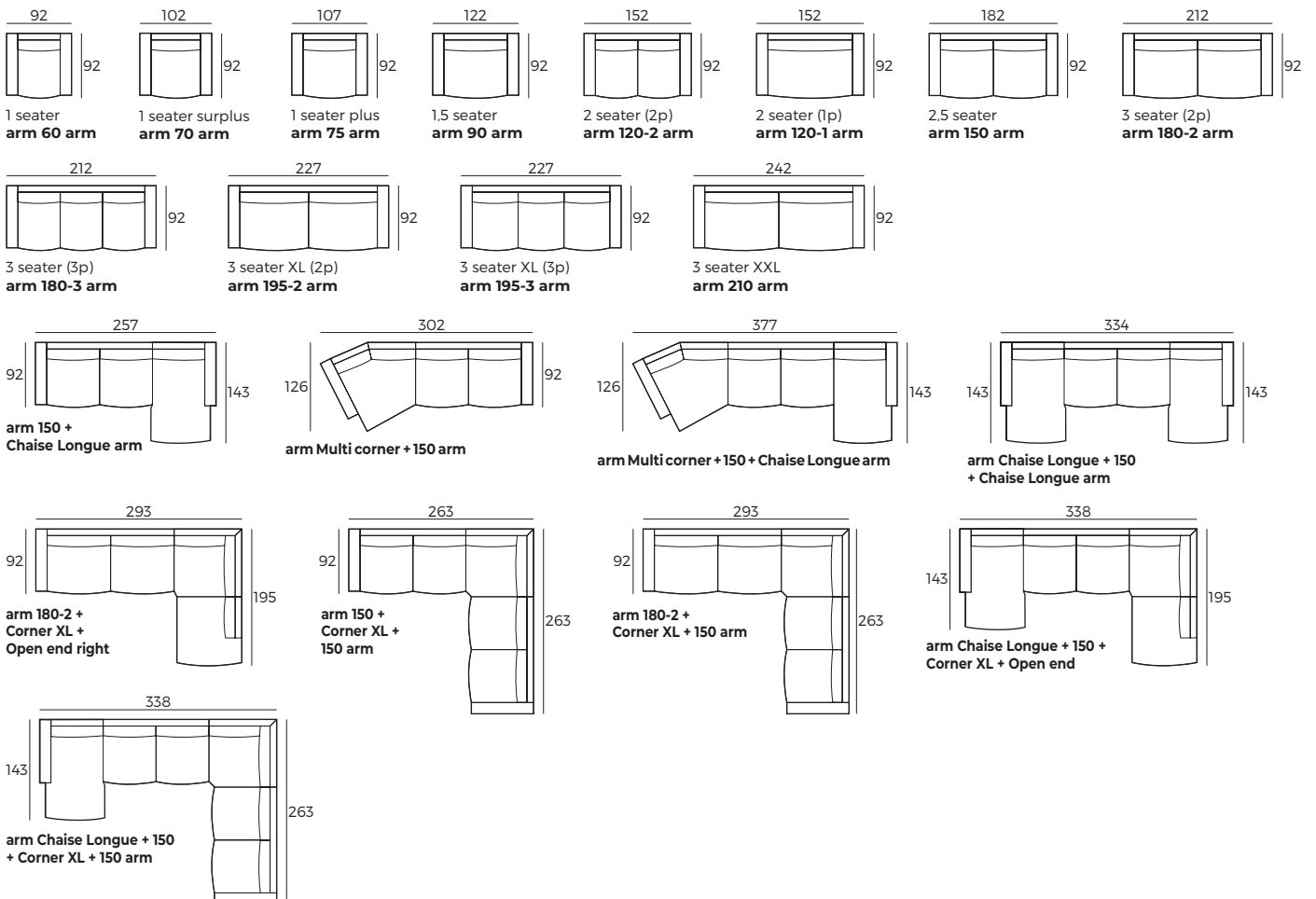

NORDIC

Combinations

Scale 1:100

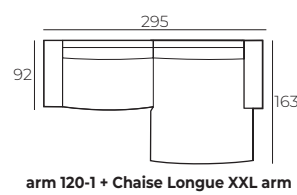
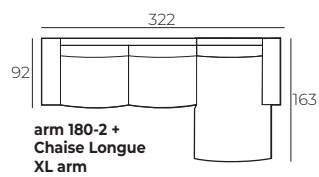
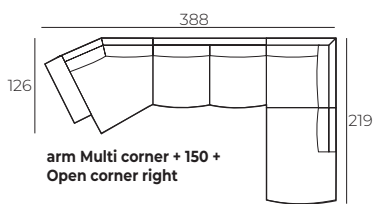
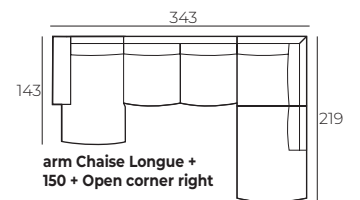
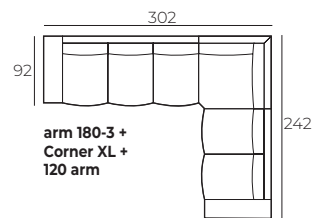
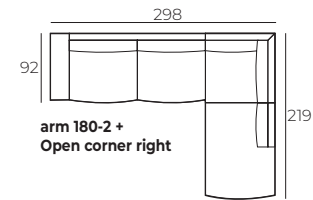
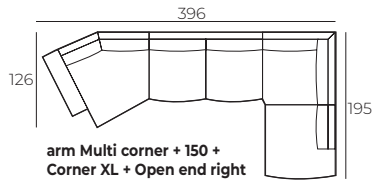
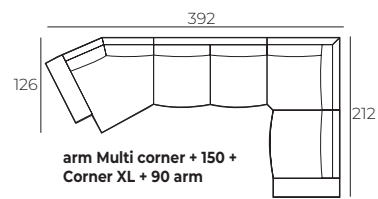
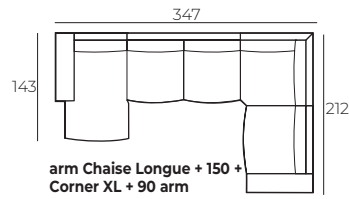
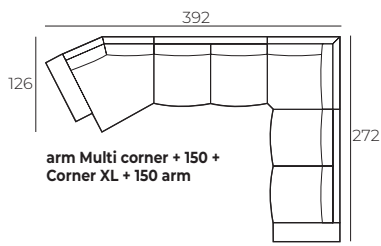

Accessories

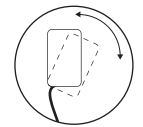
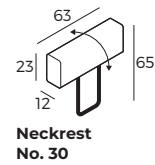
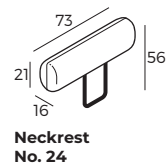
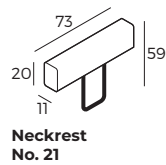
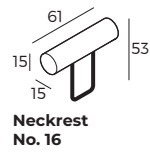
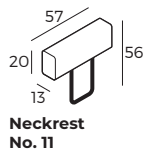
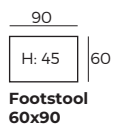
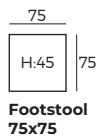

With click-clack
function